



ELMO S.R.L.

Viale Certosa, 8/B – Pavia (Italy)

www.elmoitaly.com



# MED-UP

## WITH ENCODER

(for part N. “U0W(g).....”)



## Introduction

This document contains all the information for the installation and use of the drive **MED-UP with encoder**. It consists of the following manuals:

- 1) *Simplified installation instructions for the drive MED-UP with encoder*, intended for personnel performing the installation and commissioning of the drive;
- 2) *Management of the commands of the drive MED-UP with encoder and the auxiliary connections*, for the design of the interface for management of the drive. It should be of the interest of elevator control panel manufacturer, but can also affect the personnel carrying out the commissioning of the inverter;
- 3) *MED-UP with encoder programming manual*, intended for inverter programming. Its use is intended for qualified personnel with an adequate knowledge on the use of a variable speed electrical drives.

## SIMPLIFIED INSTALLATION INSTRUCTIONS FOR THE DRIVE

# MED-UP

## WITH ENCODER

(for part N. “U0W(g).....”)



# IMPORTANT OPERATING AND SAFETY INSTRUCTIONS



## WARNING: DANGER OF ELECTRICAL DISCHARGE

THE MED IS UNDER DANGEROUS VOLTAGES AND CONTAINS PARTS IN MOVEMENTS (FAN).

### 1) WARNING

TO GUARANTEE THE SAFETY OF THE PERSONS IT IS OBLIGATORY TO **SUPPLY WITH AN ACCURATE GROUNDING THE MED** AND THE SYSTEM OF WHICH IT IS PART IN ORDER TO DISPERSE EFFICIENTLY IN THE GROUND THE ELECTRICAL CURRENTS THAT CAN BE IN CASE OF FAILURE. THAT CONCURS TO LOWER TO SAFETY LEVELS THE VALUES OF THE CONTACT VOLTAGES.

### 2) WARNING

THE MED CONTAINS FILTER CAPACITORS IN THE DC SUPPLY CIRCUIT. AFTER TO HAVE SWITCHED OFF THE MED, IN IT IS STILL PRESENT HIGH VOLTAGE; IT IS NECESSARY TO **WAIT 5 MINUTES** BEFORE APPROACHING THE MED, ONCE SWITCHED OFF.

### 3) WARNING

FOR A CORRECT VENTILATION OF THE MED IT IS NECESSARY TO LEAVE APPROXIMATELY 100 MILLIMETERS OF FREE SPACE OVER AND UNDER THE MED AND 100 MILLIMETERS FROM EACH SIDE. NOT RESPECTING SUCH DISPOSITION CAN CAUSE A DANGEROUS MED OVERHEATING.

### 4) WARNINGS

- A WRONG CONNECTION OF THE MED CAN DESTROY OR DAMAGE IT.
- INSTALLATION, CONNECTION TO THE POWER SUPPLY, COMMISSIONING AND MAINTENANCE OPERATIONS OF THE MED MAY ONLY BE PERFORMED BY QUALIFIED SERVICE PERSONNEL, WHICH IS ABLE TO OPERATE ON LIVE VOLTAGE PARTS AND ON MECHANICAL MOVING PARTS! THE RELEVANT REGULATIONS, OPERATING AND SAFETY INSTRUCTIONS MUST BE OBSERVED. IGNORE THE SAFETY INSTRUCTIONS COULD CAUSE INJURY!
- THE CORRECT OPERATION OF THE MED PRESUPPOSES AN ADEQUATE TRANSPORT, INSTALLATION, ASSEMBLY AND MAINTENANCE.
- THE INSTALLATION OF THE MED IS MADE UNDER THE RESPONSIBILITY OF THE OPERATOR, SUCH INSTALLATION MUST BE CARRIED OUT ACCORDING TO THE SAFETY PRESCRIPTION.
- THE CONNECTIONS TO THE POWER SUPPLY MUST BE MADE WITH A PROPER SIZING OF THE LEADS AND OF THE RELATED SHORT-CIRCUIT+OVERLOAD PROTECTION DEVICES IN ORDER TO GUARANTEE A SAFETY OPERATION.
- DO NOT CONNECT CAPACITORS ON MOTOR SIDE OF THE DRIVER BUT ONLY INDUCTIVE LOADS.
- DO NOT MOUNT THE MED WITHOUT PROTECTIONS AGAINST BAD WEATHER, BUT PROVIDE A PROPER PROTECTION OR COVER.
- BE SURE THAT THE CONNECTION OF THE SIGNAL SHIELD IS CORRECTLY MADE.
- PREFERABLY USE THE MED KEYBOARD WITH THE STOPPED MOTOR AND IN ABSENCE OF EXTERNAL COMMAND.
- THE MED GIVES AN OUTPUT VOLTAGE EQUAL TO 400 V. **THE MOTOR MUST BE IN DELTA (Δ) OR STAR (Y) CONNECTION, ACCORDING TO THE OUTPUT VOLTAGE OF THE MED.**

ABOUT THE CONNECTION, PLS. CONSULT THE WIRING DIAGRAM SUPPLIED WITH THE MOTOR BY THE MOTOR MANUFACTURER.

**5) IMPORTANT CAUTION**

THE MED IS SUPPLIED WITH AN **EMC** FILTER, IN ACCORDANCE TO THE ELECTROMAGNETIC STANDARD (EN12015, EN12016). BECAUSE OF FILTER, A **300 mA "B" TYPE** (ALTERNATIVELY "A" TYPE) RCD DEVICE (RESIDUAL CURRENT DEVICE OR DIFFERENTIAL RELAY) MUST BE USED. DO NOT EMPLOY ANY DIFFERENT TYPE (IN TERMS OF CLASS AND/OR SENSITIVITY) OF RCD DEVICE TO AVOID AN UNDESIRE OPERATION.

**6) IMPORTANT CAUTION**

BE SURE THAT THE GROUND OF THE MED IS CORRECTLY CONNECTED TO THE EARTH. **DO NOT INSTALL THE MED UNGROUNDED**. THE EARTH CONNECTION MUST BE DONE ACCORDINGLY TO THE ELECTRICAL STANDARDS.



CAUTION: THE INFORMATION CONTAINED HEREIN MAY BE MODIFIED WITHOUT NOTICE. **MAKE SURE YOU HAVE THE LATEST VERSION OF THIS DOCUMENT.**

# SUITABLE SYSTEM COMPONENTS

The MED can be used on normal hydraulic systems simply replacing the motor and using a conventional set of valves. More in detail it is necessary:

✓ **Motor:**

- 400V – 50 Hz (on request, can even be used a 60 Hz motor)
- equipped with a speed sensor (digital encoder) fitted on the motor shaft
- suitable for a VVVF driver
- optimized for the MED
- **THE MOTOR MUST BE IN DELTA OR STAR CONNECTION ACCORDING TO THE OUTPUT VOLTAGE OF THE MED (400 V)**

✓ **Pump:**

- a normal screw pump with low leakage

✓ **Set of valves:**

- equipped with downward valve (solenoid valve usually called EB);
- equipped with high speed valve for upward and downward (solenoid valve usually called EA);
- equipped with the valve (or device) that allows the motor to start in upward direction without any load (solenoid valve usually called ES);

or, alternatively, BLAIN type valve:

- equipped with high and low speed valves for downward (solenoid valves usually called “C” and “D”);
- equipped with low and high speed valves for upward (solenoid valves usually called “A” and “B”)

✓ **Hydraulic circuit:**

- the usual, **free of air (air releasing)**. Use good quality oil only.

✓ **Control panel:**

- The MED can be located externally or internally to the control panel. It must make sure that there is sufficient ventilation for the cooling of the MED.
- The MED needs the ENABLE command for the correct functions. In absence of the ENABLE command, the MED does not operate any action, but it is possible only to program it.
- The MED reads the three traditional command: UP (Up) - FAST (V) - MAINTENANCE (M).
- The double safety contactors must be placed on the MED output side (not input side), the contactors placed between the MED and the motor must be excited in advance (or at least at the same time) with respect to the Up command and must be released with a delay of 2 seconds to the release of this signal (or use the information coming from the signal *I on Motor*, see page 8/15).
- Supply the solenoid valves just mentioned directly from the lift control panel (for their operating logic, see pages 13/15 and 14/15).

**N.B. The MED is not intended to supply solenoid valves above mentioned.**



**WARNING: THE MED GIVES AN OUTPUT VOLTAGE EQUAL TO 400 V. THE MOTOR MUST BE IN DELTA OR STAR CONNECTION ACCORDING TO THE OUTPUT VOLTAGE OF THE MED.**

# MECHANICAL ASSEMBLING

## Mechanical Assembling:

**Vertical** to wall: it must be provided an **air recirculation** around to the MED and in the closet that contains it. The MED must be fixed by means of four screws or bolts through the appropriate side.

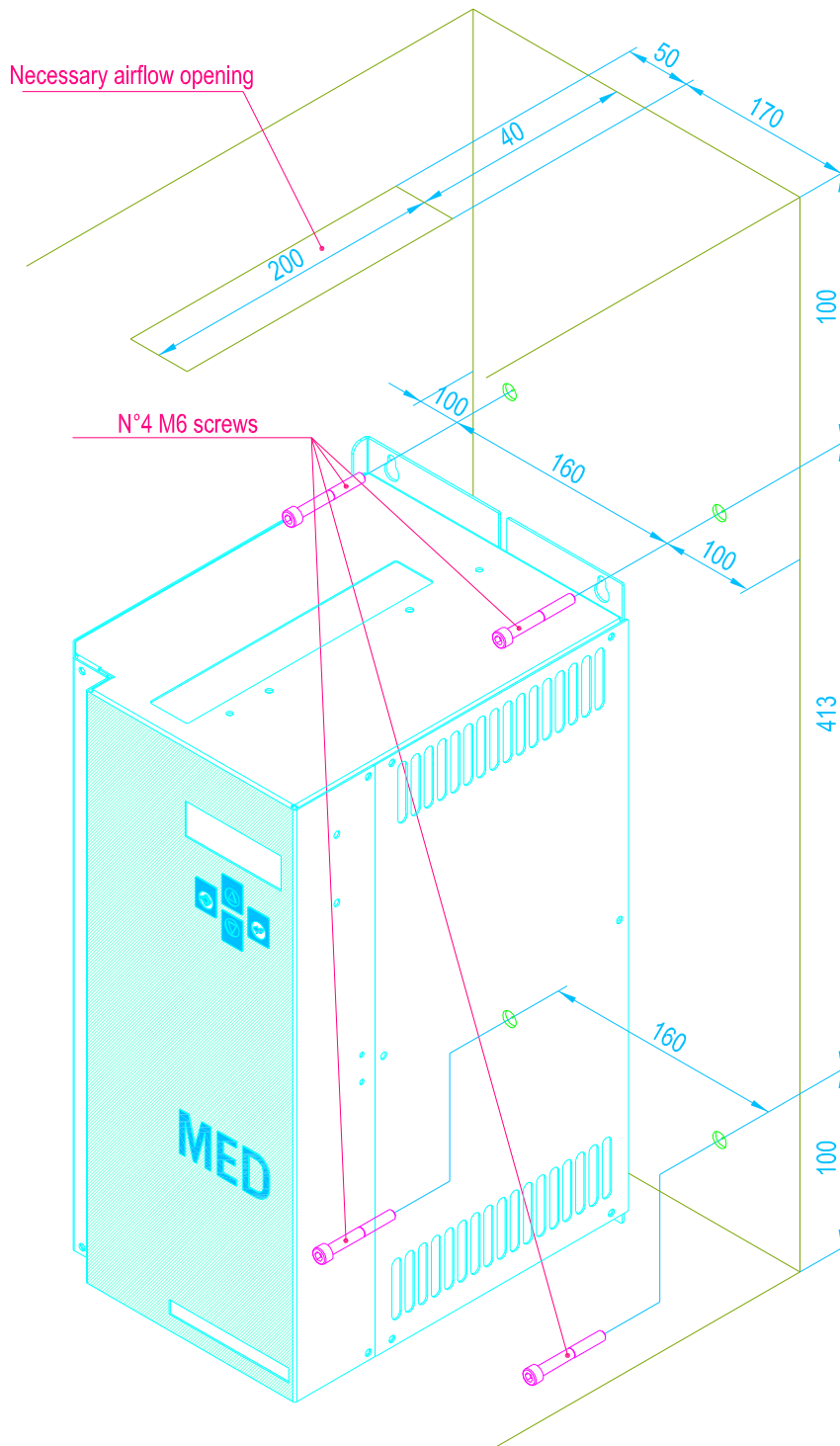

# POWER ELECTRICAL CONNECTIONS

3 wires + the earth arrive to the MED and 3 wires + the earth leave to the motor. Relatively to Electromagnetic Compatibility (**EMC**) a filter for the emissions can be used in series to the feeding line, while for the **conduct** emissions the MED is already equipped with **an internal filter** that will reduce the total harmonic distortion factor (**THD**) within the **limit of 35 %**, at nominal load.

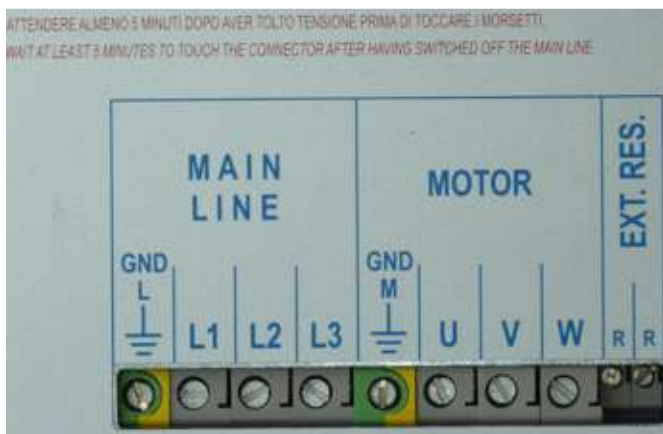

In the event that the lead length is more than 3 m, a shielded cable is advised

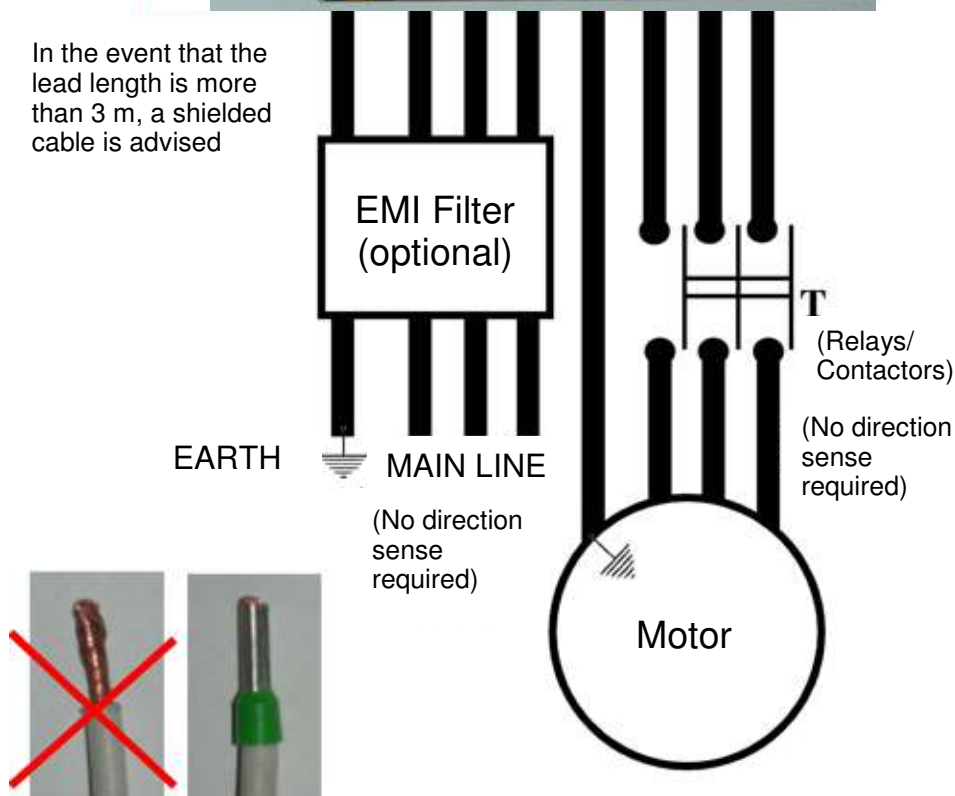

SIZE	$I_L$ [A]	$I_M$ [A]	FUSE [A]	MINIMUM WIRE [mm <sup>2</sup> ]
MED 15	< 16,5	18	25	3 x 4 + 1Y4
MED 25	< 22	24	25	3 x 4 + 1Y4
MED 50	< 29	32	35	3 x 4 + 1Y4
MED 75	< 40	45	50	3 x 6 + 1Y6
MED 100	< 54	60	63	3 x 10 + 1Y10



# CONTROL ELECTRICAL CONNECTION

For the normal operation of MED with **DIGITAL ENCODER**:

- **arrive** to the MED from the control panel:
  - a) 5 cables for the **movement command**: **ENABLE** ( $\omega$ -rif/Enable) – **Up** – **V** – **M** – **GNDs** (=ground) + shield;
- **leave** the MED:
  - b) 4 cables of **connection to the motor speed sensor** + shield;
  - c) **2 cables for any sensor mounted directly on the motor to compensate the pump leakage** (terminals labelled CT Sensor).

The other input/output are for special functions and diagnostic only. **DO NOT USE**.

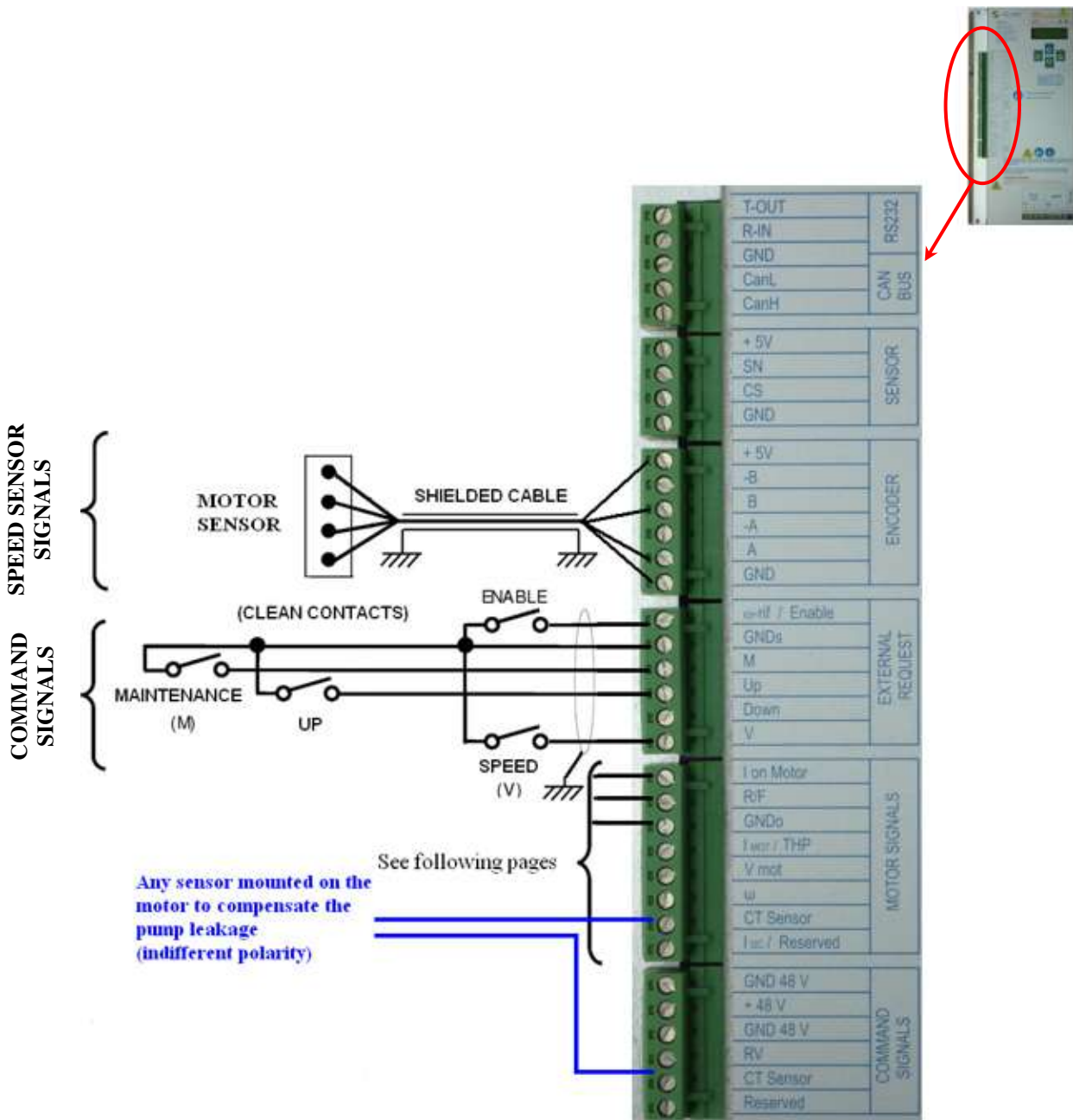

# CONNECTION TO THE “I ON MOTOR” SIGNAL

- OPTION n° 1: CONNECTION TO THE CONTROL BOARD OF THE ELEVATOR CONTROL PANEL

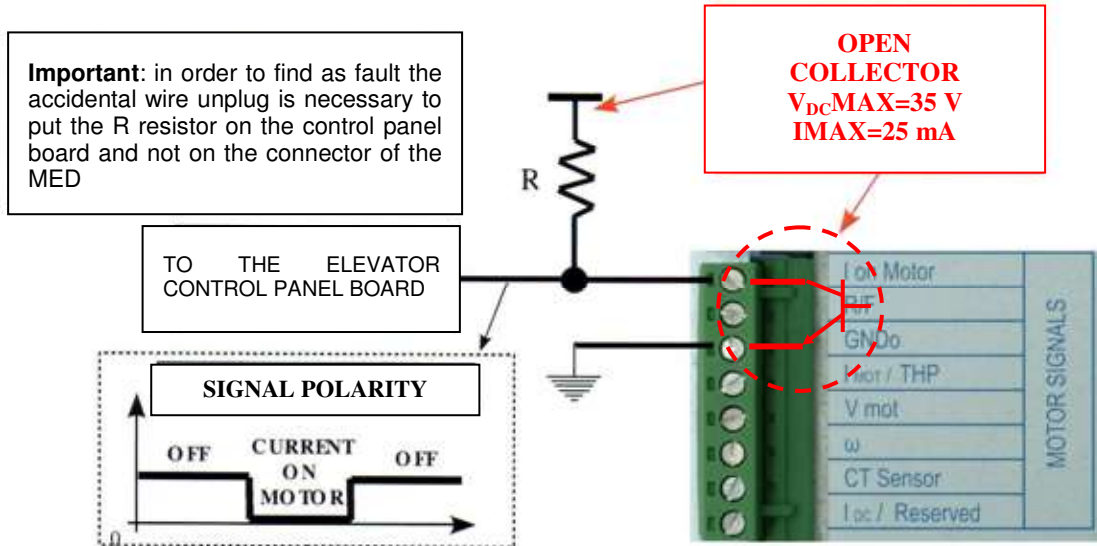

- OPTION n° 2: RELAY CONNECTION (in parallel with the relay coil, connect a suitable wheeling diode)

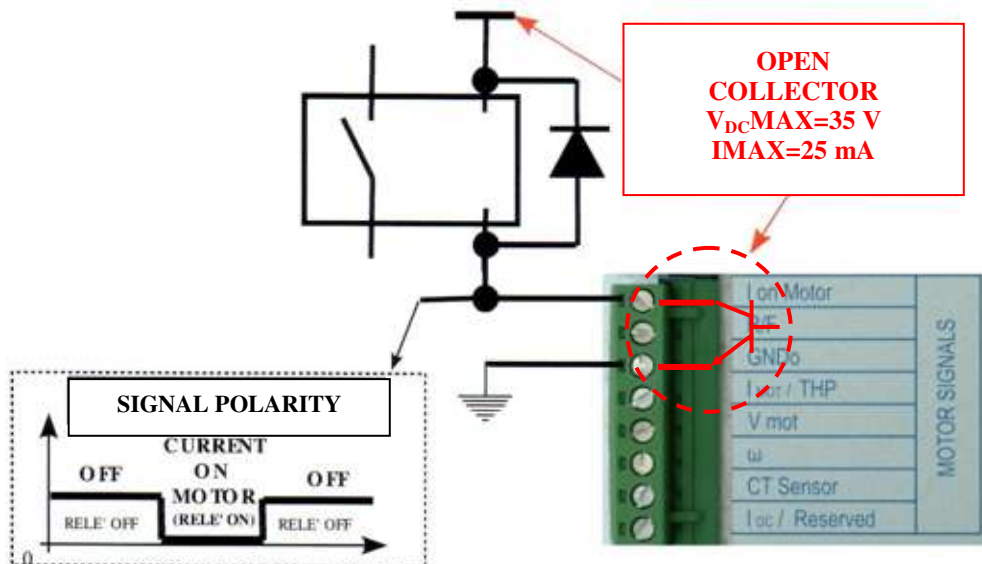

# CONNECTION TO THE "R/F" SIGNAL

- OPTION n° 1: CONNECTION TO THE CONTROL BOARD OF THE ELEVATOR CONTROL PANEL

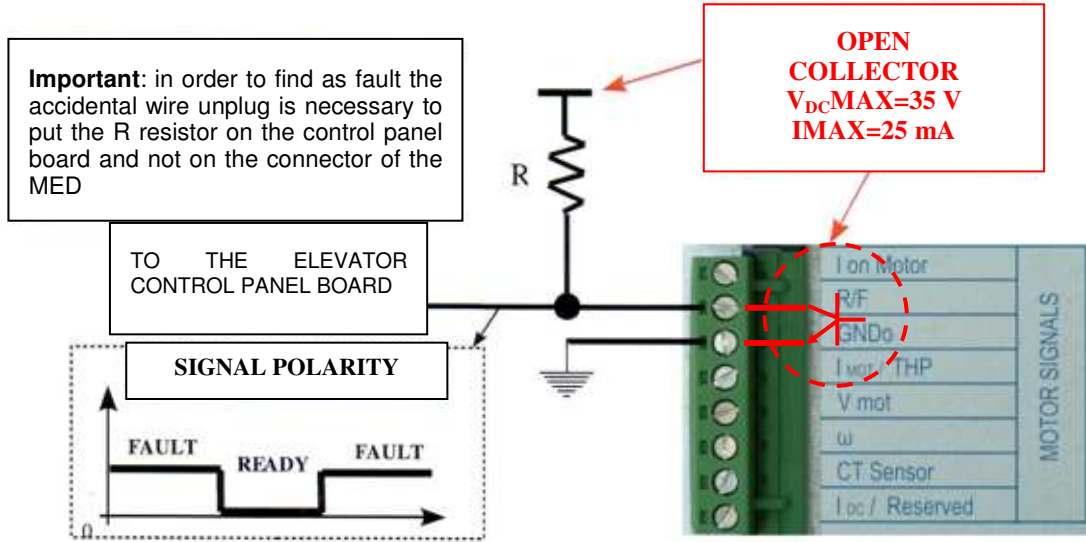

- OPTION n° 2: RELAY CONNECTION (in parallel with the relay coil, connect a suitable wheeling diode)

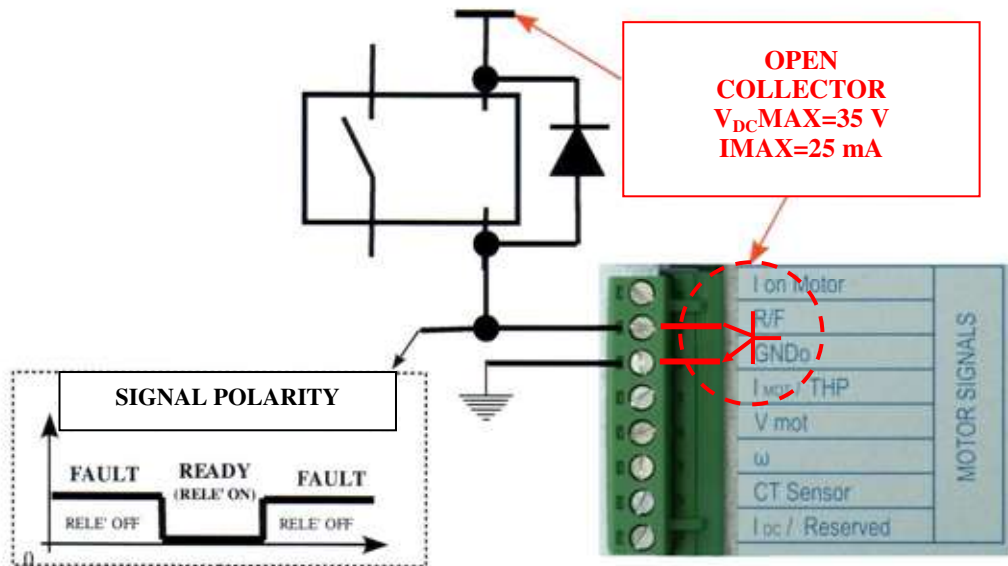

On demand, the signal R/F can inform about the error code as shown in the following figure.

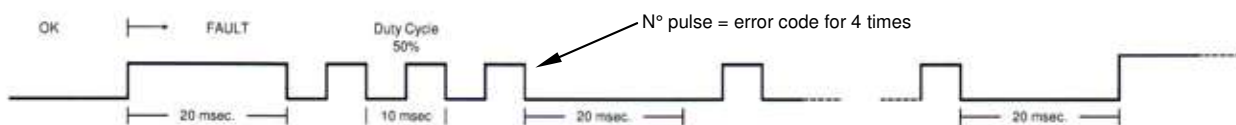

# OPERATION SETTINGS

## Switch on

After to have mounted and connected the driver MED, supply it through three phase line 400 V 50/60 Hz. When the voltage of the MED is stabilized, the display will show “med XXX vXXX.X”. **At that point the MED is ready.** The initial set-up is shown in the table below.

Language			English	
LCD contrast			60	%
Backlight			AUTO	
Keyboard beep			ON	
Upward speed	Positioning/Relevelling	$V_{ps}$	300	[rpm]
	Halfspeed	$V_{bs}$	2400	[rpm]
	Manintenance	$V_{ms}$	600	[rpm]
	Maximum	$V_{ns}$	2750 <sup>(1)</sup>	[rpm]
Upward time	Acceleration	$t_{as}$	1	[s]
	Deceleration	$t_{ds}$	2,5	[s]
Space tune			OFF	
Oil filling			OFF	
Motor selection			14,7 (no flywheel) <sup>(2)</sup>	[kW]
Pump selection			125	[l/min]

<sup>(1)</sup>2750 rpm if you are using a 50 Hz motor, 3300 rpm if you are using a 60 Hz motor

<sup>(2)</sup>14,7 kW (no flywheel) if you are using a 50 Hz motor, 15 kW (no flywheel) if you are using a 60 Hz motor

## Operation

For the corrected operation of the MED and the elevator, it is required the following sets of actions:

- Language selection** (parameter 01), if necessary;
- Motor selection** (parameter 32);
- Pump selection** (parameter 33);
- Oil filling** (parameter 31);
- Maximum power selection** (parameter 16);
- Space tuning selection** (parameter 30).

The above procedures are described in the manual “MED-UP with encoder programming manual”. Refer to it for the choice of the operating modality of the MED.

## Important for the installer

The Travel Setting Rise Sensor (TSR Sensor in the following) must be mounted as close as possible to the deceleration magnet, as described in page 12/15. Alternatively, proceed as follows:

- the TSR sensor at the lower floor must be positioned at the same distance of the deceleration magnets of the other floors, while the deceleration magnet of the lower floor must be positioned at the same distance or not more than 2 cm above;
- the TSR sensor at the upper floor must be positioned at the same distance of the deceleration magnets of the other floors, while the deceleration magnet of the upper floor must be positioned at the same distance or not more than 2 cm below.

Avoiding to respect the above conditions, during the TSR phase, the car can overpass the floor for the same distance of the TSR sensor and the deceleration magnet distance. If it is not possible to position the magnets as said above, alternatively close the high speed valve when the TSR phase starts (check the most convenience condition with the control panel manufacturer).



WARNING: The space tuning must be selected only when the magnets are definitively positioned. **DO NOT MOVE THE MAGNETS WITH THE SPACE TUNING ON.**



WARNING: Space tune must be activated preferably with cold oil.

# COMMAND SEQUENCE

The following diagram shows the command sequence signals for the MED correct operation. Refer to the "Management of the commands of the drive MED-UP with encoder and the auxiliary connections" manual for a correct sequence and functionality of the MED.

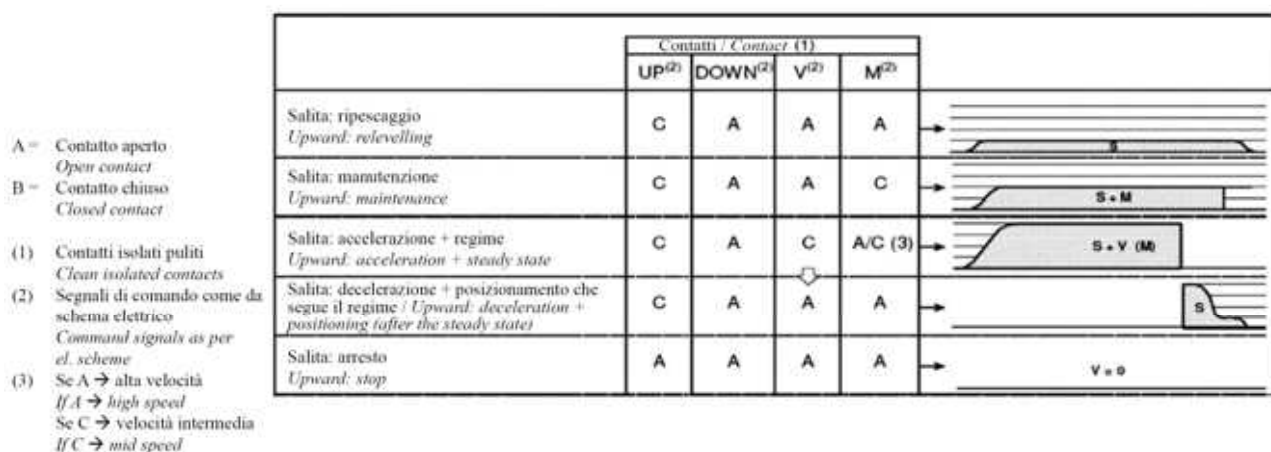

The commands V and M do not have any effect without the direction command Up. The command Up without V and M performs the releveling and the movement in upward direction at the positioning speed. To be sure that the MED reads the command as high speed, half speed or maintenance, it is necessary that the commands V and M are given before or at least within 500 ms from the Up arrival. Later than this time all commands will be denied.

## FLOOR SENSOR POSITIONING

The TSR sensors must be positioned before that the deceleration magnets. If it is not possible to do it because the control panel does not accept this working condition, the TSR sensors must be positioned maximum 2 cm after the deceleration magnets and anyway at the same distance of the deceleration magnet of the other floors.

Place the upward deceleration magnets according to the following table. In the event that the distances of the upward deceleration magnets are lower than the value indicated in the table, if the space tuning is active (ON) the MED will reduce the maximum speed to allow an optimal levelling.



**WARNING:** it is advised to position all the upward deceleration magnets at the same distance from the levelling magnets to obtain a precise and uniform space tuning (see following table)

<b>Minimum deceleration distances [mm]</b>					
<b>Deceleration time [s]</b>	<b>Car speed [m/s]</b>				
	<b>0,4</b>	<b>0,6</b>	<b>0,8</b>	<b>1</b>	<b>1,2</b>
<b>&lt;2</b>	600	900	1200	1500	1800
<b>2-3</b>	800	1200	1600	2000	2400

# SOLENOID VALVE POWER SUPPLY

- OPTION n° 1: SET OF VALVES EQUIPPED WITH DOWNWARD VALVE (SOLENOID VALVE USUALLY CALLED EB), HIGH SPEED VALVE FOR UPWARD AND DOWNWARD (SOLENOID VALVE USUALLY CALLED EA) AND VALVE (OR DEVICE) THAT ALLOWS THE MOTOR TO START IN UPWARD DIRECTION WITHOUT ANY LOAD (SOLENOID VALVE USUALLY CALLED ES)

- 1) Supply the **solenoid valve called ES** directly from the lift control panel as follows:
  - a) **ON:** in upward direction only, with any speed request (relevelling, maintenance, maximum or half speed). It must be energized when the command UP comes with a  $t_1$  excitation delay (range from 0,1 to 2,5 s) adjustable by the lift control panel and remains energized for the all duration of the mission;
  - b) **OFF:** when the car reaches the floor with a  $t_2$  release delay (range from 0,1 to 2,5 s) adjustable by the lift control panel.

**N.B. The MED is not intended to supply solenoid valve usually called ES.**

- 2) Supply the **downward solenoid valve** directly from the lift control panel as follows:
  - a) **ON:** in downward direction only, with any speed request (relevelling, maintenance, maximum or half speed). It must be energized when the downward command comes and remains energized for the all duration of the mission;
  - b) **OFF:** when the car reaches the floor.

**N.B. The MED is not intended to supply downward solenoid valve.**

- 3) Supply the **high speed solenoid valve** from the lift control panel as follows:
 

upward direction

  - a) **ON:** with any speed request (relevelling, maintenance, maximum or half speed). It must be energized at the same time with the command UP provided to the MED and remains energized for the all duration of the mission;
  - b) **OFF:** at the end of the mission, when the command UP goes OFF.

downward direction

  - a) **ON:** for high speed missions only (in maintenance missions also if done at high speed). It must be energized at the beginning of the mission;
  - b) **OFF:** when the car reaches the deceleration magnet.

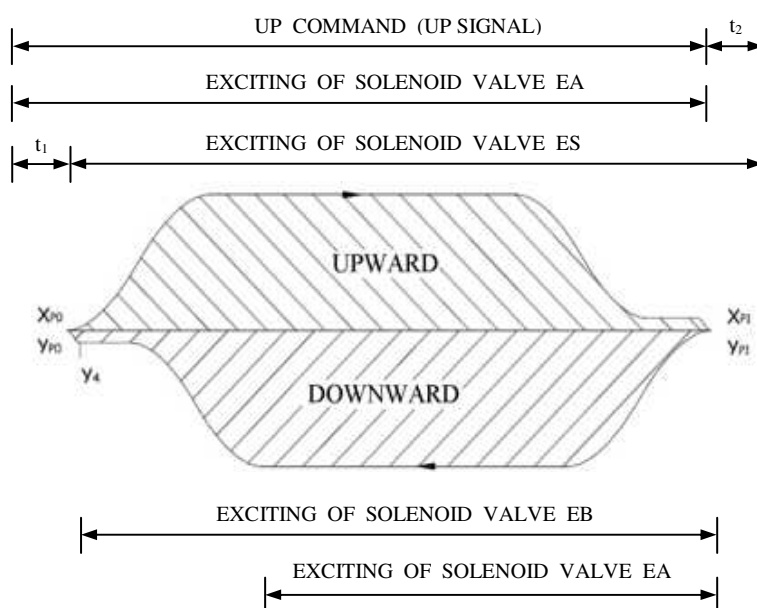

Solenoid valve excitation timing – option n° 1

# BLAIN VALVE POWER SUPPLY

- OPTION n° 2: SET OF VALVES EQUIPPED WITH HIGH AND LOW SPEED VALVES FOR DOWNWARD (SOLENOID VALVES USUALLY CALLED “C”, “D”) AND LOW AND HIGH SPEED VALVES FOR UPWARD (SOLENOID VALVES USUALLY CALLED “A”, “B”)

1) Supply the **high and low speed valves for downward** directly from the lift control panel as follows:

Valve “D”

a) **ON:** in downward direction only, with any speed request (releveling, maintenance, maximum or half speed). It must be energized when the downward command comes and remains energized for the all duration of the mission;

b) **OFF:** when the car reaches the floor.

Valve “C”

a) **ON:** for downward high speed missions only (in maintenance missions also if done at high speed). It must be energized when the downward command comes;

b) **OFF:** when the car reaches the deceleration magnet.

**N.B. The MED is not intended to supply downward solenoid valves.**

2) Supply the **high and low speed valves for upward** directly from the lift control panel as follows:

Valves “A” and “B”

a) **ON:** in upward direction only, with any speed request (releveling, maintenance, maximum or half speed). They should already be excited when the command UP comes and remain energized for the all duration of the mission. The lift control panel must provide to the MED the command UP with a  $t_1$  delay (range from 0,1 to 2,5 s) from the excitation of the solenoid valves “A” and “B”;

b) **OFF:** when the car reaches the floor with a  $t_2$  release delay (range from 0 to 2,5 s) adjustable by the lift control panel.

**N.B. The MED is not intended to supply upward solenoid valves.**

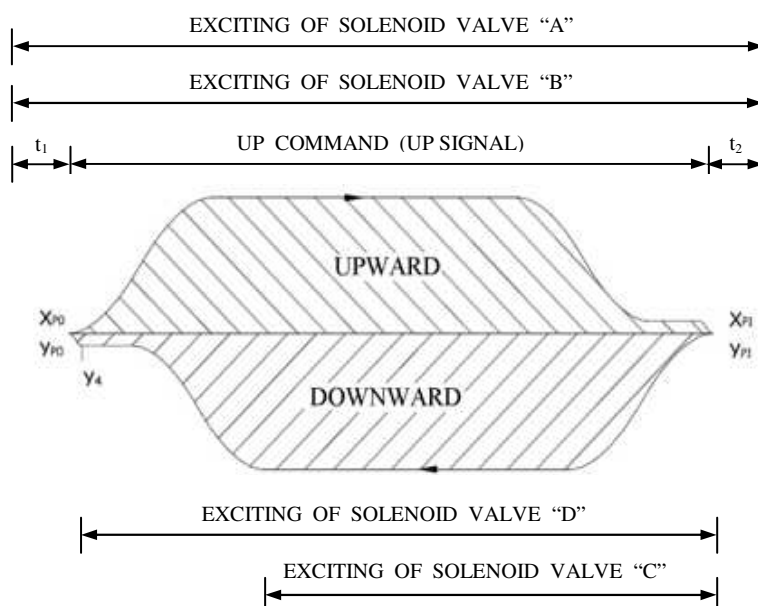

Solenoid valve excitation timing – option n° 2



# SIZING OF THE HYDRAULIC COMPONENT

## Dimensioning of the hydraulic circuit components

data:	$P_a$	= .....	[kg]	(whole elevator load)
	$V_a$	= .....	[m/s]	(elevator speed)
	$\eta_i$	= .....		(hydraulic efficiency)
	$\eta_m$	= .....		(motor efficiency)
	$\eta_{INV}$	= .....		(inverter efficiency)
→	$W_m$	$= \frac{P_a \cdot V_a}{102 \cdot \eta_i} = \dots\dots$	[kW]	(motor shaft power)
→	$W_L$	$= \frac{W_m}{\eta_m \cdot \eta_{INV}} = \dots\dots$	[kW]	(power supplied by the main line)
1) data:	$D_C$	= .....	[mm]	(cylinder diameter)
	$K_t$	= .....	(transmission ratio)	$\left\{ \begin{array}{l} = 1 \text{ for direct action} \\ = 2 \text{ for reeving ratio } 2 : 1 \end{array} \right.$
→	$P_C$	$= 127 \cdot \frac{P_a \cdot K_t}{D_C^2} = \dots\dots$	[bar]	(cylinder pressure)
2) or data Q:	$V_a$	$= 21,2 \cdot \frac{Q \cdot K_t}{D_C^2} = \dots\dots$	[m/s]	(elevator speed)
→	$Q$	$= \frac{V_a \cdot D_C^2}{21,2 \cdot K_t} = \dots\dots$	[lt/min]	(pump flow rate)

## Management of the commands of the drive

# MED-UP

## WITH ENCODER

and the

# Auxiliary Connections

(for part N. "U0W(g).....")

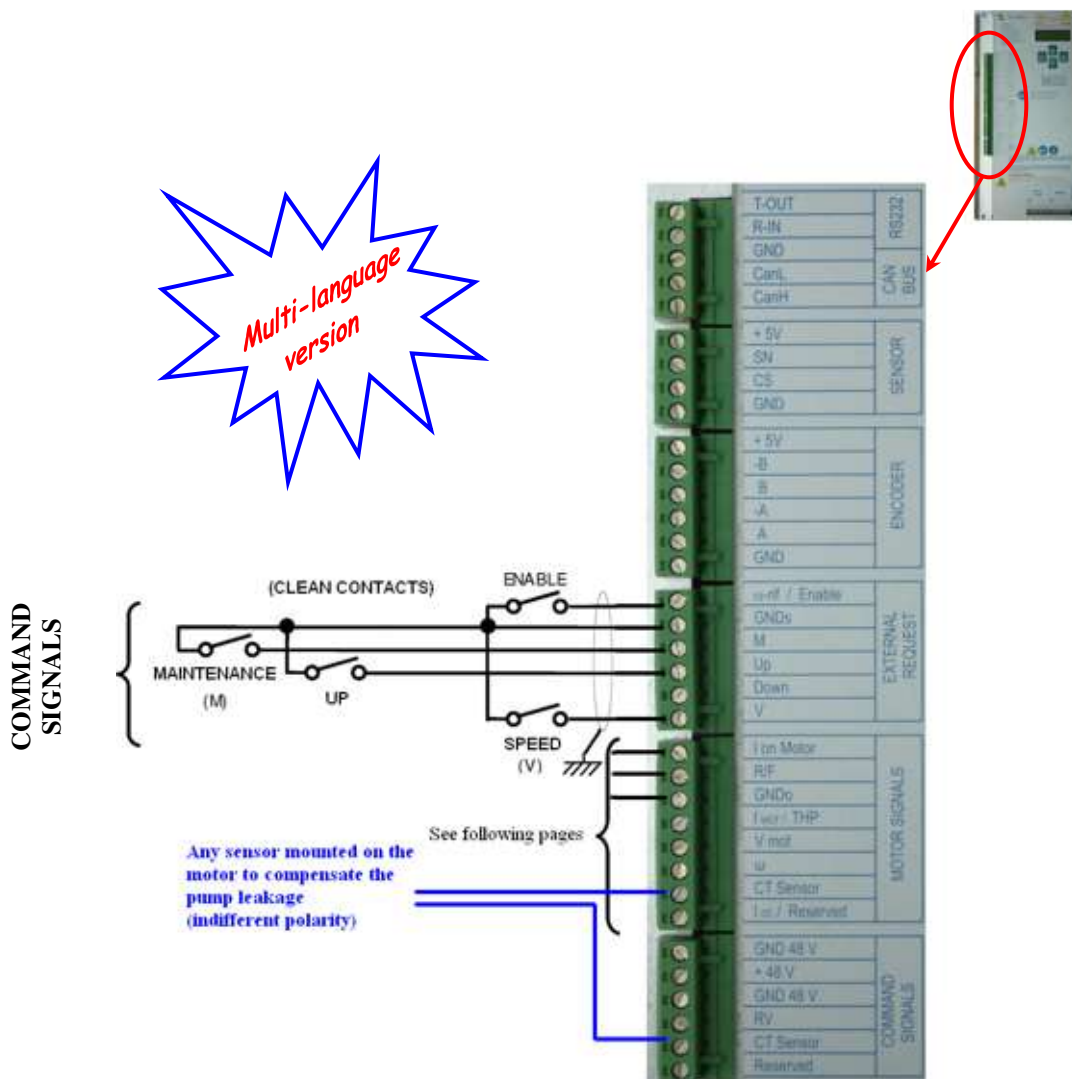

# IMPORTANT OPERATING AND SAFETY INSTRUCTIONS



## WARNING: DANGER OF ELECTRICAL DISCHARGE

THE MED IS UNDER DANGEROUS VOLTAGES AND CONTAINS PARTS IN MOVEMENTS (FAN).

### 1) WARNING

TO GUARANTEE THE SAFETY OF THE PERSONS IT IS OBLIGATORY TO **SUPPLY WITH AN ACCURATE GROUNDING THE MED** AND THE SYSTEM OF WHICH IT IS PART IN ORDER TO DISPERSE EFFICIENTLY IN THE GROUND THE ELECTRICAL CURRENTS THAT CAN BE IN CASE OF FAILURE. THAT CONCURS TO LOWER TO SAFETY LEVELS THE VALUES OF THE CONTACT VOLTAGES.

### 2) WARNING

THE MED CONTAINS FILTER CAPACITORS IN THE DC SUPPLY CIRCUIT. AFTER TO HAVE SWITCHED OFF THE MED, IN IT IS STILL PRESENT HIGH VOLTAGE; IT IS NECESSARY TO **WAIT 5 MINUTES** BEFORE APPROACHING THE MED, ONCE SWITCHED OFF.

### 3) WARNING

FOR A CORRECT VENTILATION OF THE MED IT IS NECESSARY TO LEAVE APPROXIMATELY 100 MILLIMETERS OF FREE SPACE OVER AND UNDER THE MED AND 100 MILLIMETERS FROM EACH SIDE. NOT RESPECTING SUCH DISPOSITION CAN CAUSE A DANGEROUS MED OVERHEATING.

### 4) WARNINGS

- A WRONG CONNECTION OF THE MED CAN DESTROY OR DAMAGE IT.
- INSTALLATION, CONNECTION TO THE POWER SUPPLY, COMMISSIONING AND MAINTENANCE OPERATIONS OF THE MED MAY ONLY BE PERFORMED BY QUALIFIED SERVICE PERSONNEL, WHICH IS ABLE TO OPERATE ON LIVE VOLTAGE PARTS AND ON MECHANICAL MOVING PARTS! THE RELEVANT REGULATIONS, OPERATING AND SAFETY INSTRUCTIONS MUST BE OBSERVED. IGNORE THE SAFETY INSTRUCTIONS COULD CAUSE INJURY!
- THE CORRECT OPERATION OF THE MED PRESUPPOSES AN ADEQUATE TRANSPORT, INSTALLATION, ASSEMBLY AND MAINTENANCE.
- THE INSTALLATION OF THE MED IS MADE UNDER THE RESPONSIBILITY OF THE OPERATOR, SUCH INSTALLATION MUST BE CARRIED OUT ACCORDING TO THE SAFETY PRESCRIPTION.
- THE CONNECTIONS TO THE POWER SUPPLY MUST BE MADE WITH A PROPER SIZING OF THE LEADS AND OF THE RELATED SHORT-CIRCUIT+OVERLOAD PROTECTION DEVICES IN ORDER TO GUARANTEE A SAFETY OPERATION.
- DO NOT CONNECT CAPACITORS ON MOTOR SIDE OF THE DRIVER BUT ONLY INDUCTIVE LOADS.
- DO NOT MOUNT THE MED WITHOUT PROTECTIONS AGAINST BAD WEATHER, BUT PROVIDE A PROPER PROTECTION OR COVER.
- BE SURE THAT THE CONNECTION OF THE SIGNAL SHIELD IS CORRECTLY MADE.
- PREFERABLY USE THE MED KEYBOARD WITH THE STOPPED MOTOR AND IN ABSENCE OF EXTERNAL COMMAND.
- THE MED GIVES AN OUTPUT VOLTAGE EQUAL TO 400 V. **THE MOTOR MUST BE IN DELTA (Δ) OR STAR (Y) CONNECTION, ACCORDING TO THE OUTPUT VOLTAGE OF THE MED.**

ABOUT THE CONNECTION, PLS. CONSULT THE WIRING DIAGRAM SUPPLIED WITH THE MOTOR BY THE MOTOR MANUFACTURER.

**5) IMPORTANT CAUTION**

THE MED IS SUPPLIED WITH AN **EMC** FILTER, IN ACCORDANCE TO THE ELECTROMAGNETIC STANDARD (EN12015, EN12016). BECAUSE OF FILTER, A **300 mA "B" TYPE** (ALTERNATIVELY "A" TYPE) RCD DEVICE (RESIDUAL CURRENT DEVICE OR DIFFERENTIAL RELAY) MUST BE USED. DO NOT EMPLOY ANY DIFFERENT TYPE (IN TERMS OF CLASS AND/OR SENSITIVITY) OF RCD DEVICE TO AVOID AN UNDESIRE OPERATION.

**6) IMPORTANT CAUTION**

BE SURE THAT THE GROUND OF THE MED IS CORRECTLY CONNECTED TO THE EARTH. **DO NOT INSTALL THE MED UNGROUNDED**. THE EARTH CONNECTION MUST BE DONE ACCORDINGLY TO THE ELECTRICAL STANDARDS.



CAUTION: THE INFORMATION CONTAINED HEREIN MAY BE MODIFIED WITHOUT NOTICE. **MAKE SURE YOU HAVE THE LATEST VERSION OF THIS DOCUMENT.**

## Introduction

The present manual is the reference for the command signal interface design of the **MED which performs the car movement in upward direction only**. It should be of the interest of elevator control panel manufacturer and trained personnel performing the installation and operation and / or service.

For a corrected interpretation of the MED operation, you need some preliminary consideration. The motor is not connected directly to the main net, therefore the rotation can take place only if the correct voltage is applied on the motor. The MED generates such voltage only if a correct command signal is applied to it. In case absence of the command or in case an anomaly occurs, the probability that the MED generates the correct voltage to make the motor run is zero. Therefore stopping the MED is like opening the motor power relay.

In upward direction, **in case an emergency occurs**, the opening of the motor power relay involves the instantaneous stopping of the motor. Since for new installations the motor without flywheel is used, this leads to a very sudden deceleration of the car. To overcome this drawback, delay the opening of the motor power relay of fractions of seconds (0,5-1 s), so as the MED can simulate the flywheel effect without compromising the safety of the plant.

The European Standard EN 81-2 at 14.1.2.4 *Operation of electric safety devices* says:

*When operating to ensure safety, an electric safety device shall prevent the setting in motion of the machine or initiate immediately its stopping. The electric safety devices shall act directly on the equipment controlling the supply to the machine in accordance with the requirements of 12.4. If, because of power to be transmitted, relay contactors are used to control the machine, these shall be considered as equipped directly controlling the supply to the machine for starting and stopping.*

In this case the MED shall "... prevent the setting in motion of the machine..." and "... initiate immediately its stopping (machine)..." when the electric safety devices act. Since without a correct command the MED does not create any voltage on its output, keeping closed the relays does not allow the motor to run.

**In case an emergency occurs**, although the MED is designed also to work without the opening delay of the motor power relays, **it is advised**, for the aforesaid reasons, because in agreement with the harmonized norms, **to delay the opening of the motor power relays from the opening of the emergency chain at least 1 s** or as much as possible.

## Commands

The MED is driven by the traditional elevator commands:

- UP Upward command
- V High speed command
- M Maintenance. In combination with V means middle speed.

The commands are given to the MED through “**clean contacts**” (free of potential contacts) according to the scheme reported in the manual “*Simplified installation instructions for the drive MED-UP with encoder*”. Every command is active when the contact is closed to the ground (GNDs ground of the MED).

Every command is accepted if stays in the same state for at least 600  $\mu$ s consecutive (anti-bounce function).

Although it is not required any shield for the connections to the MED for the commands, is good norm, in case the distance of cables is not short or in vicinity of sources of it disturbs, to use a shielded cable with the shielding connected to the case of the MED.

## Signals

The MED has two signals that indicates its operation:

- IonMotor the motor is under voltage and is carrying out the commanded operations: 0=powered motor, 1=unpowered motor
- R/F informs about the operating condition of the MED: 0=normal operation, 1=failure. On request the signal can give the information on the failure type (see the manual “*Simplified installation instructions for the drive MED-UP with encoder*”).

The signals are two “*open collector*” optocoupled outputs (see fig. 1). The ground reference is GND<sub>o</sub> and is isolated from the other grounds of the MED through a resistor of 1 M $\Omega$ . **The maximum current that every transistor can withstand is 25 mA. The maximum applicable voltage is 35 V of peak.** It is necessary to connect one “*pull-up*” resistor for the corrected operation. **If an inductive load is connected, it is necessary to arrange the same one of freewheeling diode** in order to avoid overvoltages on the transistor.

Although it is not required any shield for the connections to the MED for the signals, is good norm, in case the distance of cables is not short or in vicinity of sources of it disturbs, to use a shielded cable with the shielding connected to the case of the MED.

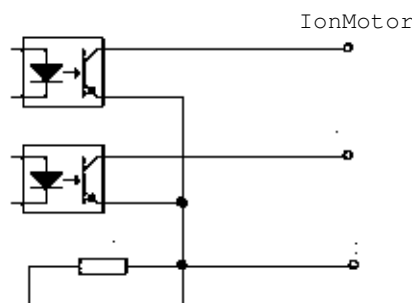

Fig. 1



CAUTION: Collector currents ( $I_{cMAX}$ ) greater than 25 mA may cause irreparable damage to the MED internal optocouplers.



CAUTION: Peak collector-emitter voltages ( $V_{CEMAX}$ ) greater than 35 V may cause irreparable damage to the MED internal optocouplers.



CAUTION: The use of inductive loads without proper freewheeling diodes could permanently damage the MED internal optocouplers.

### MED enable (ENABLE)

The MED is enabled by the ENABLE signal. The ENABLE signal must be given to the MED through a “**clean contact**” (free of potential contact) at the EXTERNAL REQUEST connector between GNDs and  $\omega$ -rif/Enable. Until the signal is OFF (open contact) the MED is not active and it will not execute any action on the other commands. Only if the contact comes closed the MED become active and it gets ready to the execution of the external commands. If during the travel or whichever action the contact comes opened the MED interrupts the action and the motor is slowed down with a slow rate of 3300 rpm/s till stops. The MED does not accept any external command in the following 2 s.



WARNING: **The ENABLE signal must be given to the MED before any other command (or at the same time).** Close the ENABLE contact before closing the contacts used for the UP command and to determine the car movement speed (M/V).



CAUTION: In normal operation, the ENABLE signal must be removed at the end of the mission with a programmable delay (range 0,5 to 4 s) from the opening of the motor power relays. Open the ENABLE contact after the opening of the motor power relays.



WARNING: **When the safety chain occurs, the ENABLE signal must be removed immediately.** Open the ENABLE contact before the opening of the motor power relays (opening late the ENABLE contact could result in dangerous situations).



WARNING: **For safety**, to enable the MED, necessarily use a contact driven by the elevator control panel. **Do not use "jumpers" applied directly to the MED EXTERNAL REQUEST terminals.**



WARNING: **The ENABLE signal must be given to the MED in upward direction only.** Do not enable the MED in downward direction.



WARNING: **The motor shall be supplied in upward direction only.** Therefore the motor power relays must be energized during an upward mission, but they must remain opened during a downward mission.

## Relevelling

When the command

- UP for the upward relevelling

occurs, the MED waits 500 ms in order to verify that there are not present also V or M or both.

In the meantime the motor power relays (RELAY) must have been closed and the high speed solenoid valve excited. Moreover the valve (or device) that allows the motor to start in upward direction without any load (solenoid valve usually called ES), if present in the hydraulic unit, must be supplied according to the timing indicated in the manual *“Simplified installation instructions for the drive MED-UP with encoder”* – page 13/15. Refer to the same manual – page 14/15 for the excitation timing of the solenoids called “A”, “B”, “C” and “D” if a valve unit type BLAIN was used.

If after the 500 ms the relevelling command has been recognized, the MED does not consider the commands V and M. The motor starts and goes to the relevelling speed (parameter 10 of the menu - see the manual *“MED-UP with encoder programming manual”*). The motor remains in that state until command UP is removed. Removed the command, the motor is stopped within the time  $t_1$  (parameter 24 of the menu - see the manual *“MED-UP with encoder programming manual”*). The motor still remains supplied for 500 ms.

The MED informs about the presence of the voltage on the motor through the signal *IonMotor*. The motor power relays must be opened after that the signal *IonMotor* goes to one.

The sequence of the signals is shown in the fig. 2.

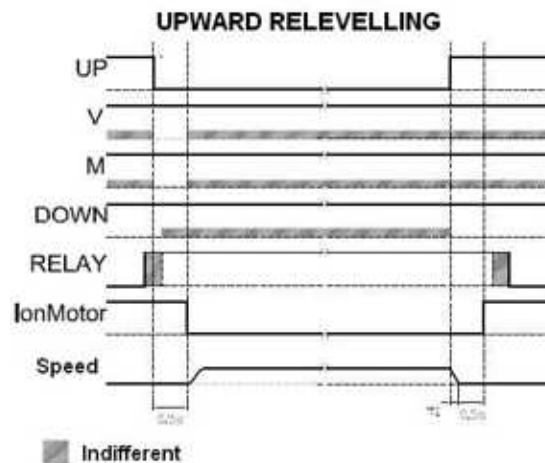

Fig. 2



**CAUTION:** Close the motor power relays before closing the contacts used for the UP command and to determine the car movement speed (M/V). Release the motor power relays with a delay of 2 seconds to the release of the above signals. To delay the motor power relay opening, you can use the information coming from the signal *IonMotor* (see the manual *“Simplified installation instructions for the drive MED-UP with encoder”* – page 4/15). Anyway in this case, for safety reasons, release the motor power relays within 5 seconds to the release of the contact used for the UP command.



**WARNING:** In case an emergency occurs, delay the opening of the motor power relays from the opening of the emergency chain at least 1 s or as much as possible.





WARNING: Enable the MED to run the motor upward by the ENABLE signal. At the end of the mission, disable the MED by the ENABLE signal. Delay the opening of the ENABLE contact from the opening of the motor power relays (see page 6/14).



WARNING: **When the safety chain occurs**, open the ENABLE contact in advance from the opening of the motor power relays (see page 6/14).

#### In case of failure

- internal to the MED: the motor stops instantaneously and after 10 seconds approximately it starts again in agreement to the new commands. Only in case of thermal protection of the IGBT module (code A01=THP-HTS), before stopping, it will slow down; the MED is restored automatically only when IGBT power module cools. In the event that the failure code is A12=THP-IPM the MED will stop and wait to cool down for the reset;
- external: if UP command goes down and returns, the MED stops the motor and starts it again in agreement to the new command when the motor is stopped, however not before 100 ms. If the motor power relays open and the commands are still present, the MED will go on in agreement to the commands, but the car will be stopped instantaneously. If in this conditions the motor power relays get closed → fault A02=ICC-IPM occurs.

## Maintenance

The maintenance signal is normally selected by an external switch, then it is already available before the following procedure.

When the command

- UP for the upward

occurs, the MED waits 500 ms in order to verify that there is not present also V with M.

In the meantime the motor power relays (RELAY) must have been closed and the high speed solenoid valve excited. Moreover the valve (or device) that allows the motor to start in upward direction without any load (solenoid valve usually called ES), if present in the hydraulic unit, must be supplied according to the timing indicated in the manual *"Simplified installation instructions for the drive MED-UP with encoder"* – page 13/15. Refer to the same manual – page 14/15 for the excitation timing of the solenoids called "A", "B", "C" and "D" if a valve unit type BLAIN was used.

If after the 500 ms the maintenance command has been recognized, the MED does not consider the commands V. The motor starts and goes to the maintenance speed (parameter 12 of the menu - see the manual *"MED-UP with encoder programming manual"*). The motor remains in that state until command UP is removed. Removed the command, the MED slows down the motor with a slope of 1600 rpm/s; the motor is stopped when the speed goes to 0 rpm. The motor still remains supplied for 500 ms.

The MED informs about the presence of the voltage on the motor through the signal IonMotor. The motor power relays must be opened after that the signal IonMotor goes to one.

The sequence of the signals is shown in the fig. 3.

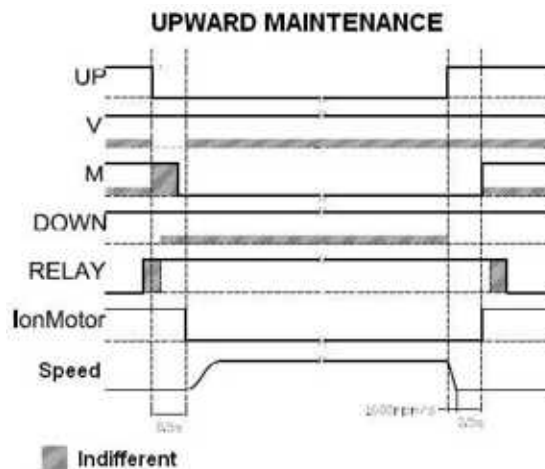

Fig. 3



**CAUTION:** Close the motor power relays before closing the contacts used for the UP command and to determine the car movement speed (M/V). Release the motor power relays with a delay of 2 seconds to the release of the above signals. To delay the motor power relay opening, you can use the information coming from the signal *IonMotor* (see the manual *"Simplified installation instructions for the drive MED-UP with encoder"* – page 4/15). Anyway in this case, for safety reasons, release the motor power relays within 5 seconds to the release of the contact used for the UP command.



**WARNING:** In case an emergency occurs, delay the opening of the motor power relays from the opening of the emergency chain at least 1 s or as much as possible.



WARNING: Enable the MED to run the motor upward by the ENABLE signal. At the end of the mission, disable the MED by the ENABLE signal. Delay the opening of the ENABLE contact from the opening of the motor power relays (see page 6/14).



WARNING: **When the safety chain occurs**, open the ENABLE contact in advance from the opening of the motor power relays (see page 6/14).

#### In case of failure

- internal to the MED: the motor stops instantaneously and after 10 seconds approximately it starts again in agreement to the new commands. Only in case of thermal protection of the IGBT module (code A01=THP-HTS), before stopping, it will slow down; the MED is restored automatically only when IGBT power module cools. In the event that the failure code is A12=THP-IPM the MED will stop and wait to cool down for the reset;
- external: if UP or M command (or both) go down and return, the MED stops the motor and starts it again in agreement to the new command when the motor is stopped, however not before 100 ms. If the motor power relays open and the commands are still present, the MED will go on in agreement to the commands, but the car will be stopped instantaneously. If in this conditions the motor power relays get closed → fault A02=ICC-IPM occurs.

## Up

When the command

- UP for the upward

occurs, the MED waits 500 ms in order to verify that there are present V or also M.

In the meantime the motor power relays (RELAY) must have been closed and the high speed solenoid valve excited. Moreover the valve (or device) that allows the motor to start in upward direction without any load (solenoid valve usually called ES), if present in the hydraulic unit, must be supplied according to the timing indicated in the manual *“Simplified installation instructions for the drive MED-UP with encoder”* – page 13/15. Refer to the same manual – page 14/15 for the excitation timing of the solenoids called “A”, “B”, “C” and “D” if a valve unit type BLAIN was used.

If after the 500 ms the upward command and the V (with or without M) have been recognized, the MED does not consider the command M any more. The motor starts and goes to the set speed (parameter 11 of the menu with V and M present, parameter 13 of the menu if only V is present - see the manual *“MED-UP with encoder programming manual”*). The motor remains in that state until the command V is removed. Removed the command V, the MED slows down with an S-shape to the positioning speed (parameter 10 of the menu - see the manual *“MED-UP with encoder programming manual”*). The slow down is delayed if the space recovery is active. Reached the positioning speed the MED remains in that state until command UP is removed. Removed the command, the motor is stopped within the time  $t_1$  (parameter 24 of the menu - see the manual *“MED with encoder programming manual”*). The motor still remains supplied for 500 ms.

The MED informs about the presence of the voltage on the motor through the signal IonMotor. The motor power relays must be opened after that the signal IonMotor goes to one. The MED does not accept any command for the successive 10 s.

The sequence of the signals is shown in the fig. 4.

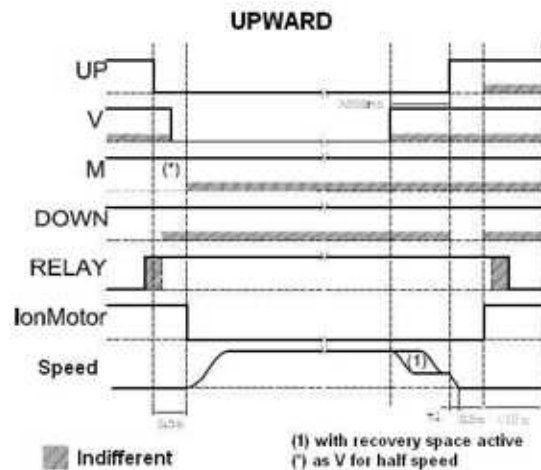

Fig. 4

During the up travel a various different events from normal operation that the MED manages can happen. In particular it can happen that the signal V goes down during the acceleration slope, and in particular before that the positioning speed has been reached or has been overpassed but the steady state speed has not been reached yet. The two events are shown in the fig. 5. If the positioning speed has not been reached, the MED drives the motor to such speed and maintains it until UP stays on. If instead it has been exceeded the positioning speed, the MED begins a slowing down from the reached speed according to S-shape to the positioning speed and remains in that state until UP stays on. The others signals (IonMotor, RELAY) remain unchanged. Another event that can happen, managed by the MED, is that the signal UP goes down during the slow down phase before that the positioning speed has been reached, shown in fig. 6. In this case the MED follows the S-shape until the positioning speed is reached and, as soon as the speed is reached, it slows down the motor with a time  $t_1$  and stops the motor when the speed is 0. In these conditions it can

happen that the car goes beyond the floor and needs to carry out the releveling. This event can happen in the following circumstances:

- if the distances between deceleration and positioning magnets are different from the suggested value indicated in the manual “Simplified installation instructions for the drive MED-UP with encoder”;
- if the deceleration magnets are not all at the same distance and the space recovery is active. In this case the MED measures the exceeding space and in the successive travel uses the smaller space for the space recovery;
- if the Travel Setting Rise sensor (TSR sensor) at the upper floor is positioned above the deceleration magnet of the upper floor and it is positioned too distant from it.

For all the circumstances do not open the motor power relays until IonMotor signal does not inform that the MED has finished its operation.

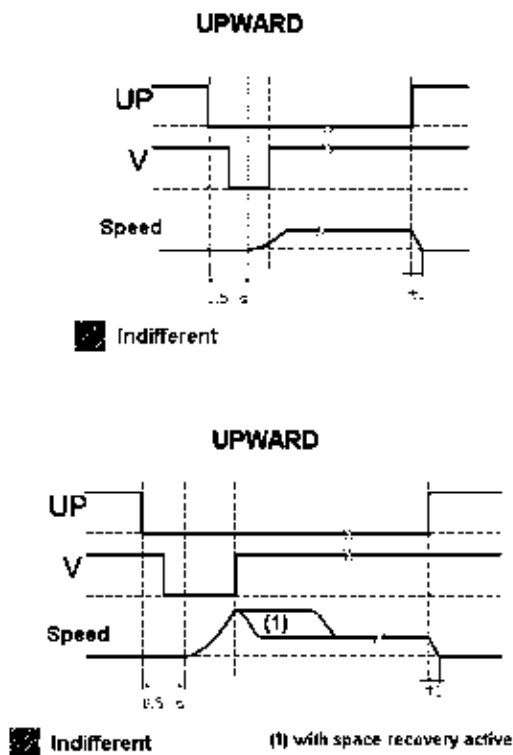

Fig. 5

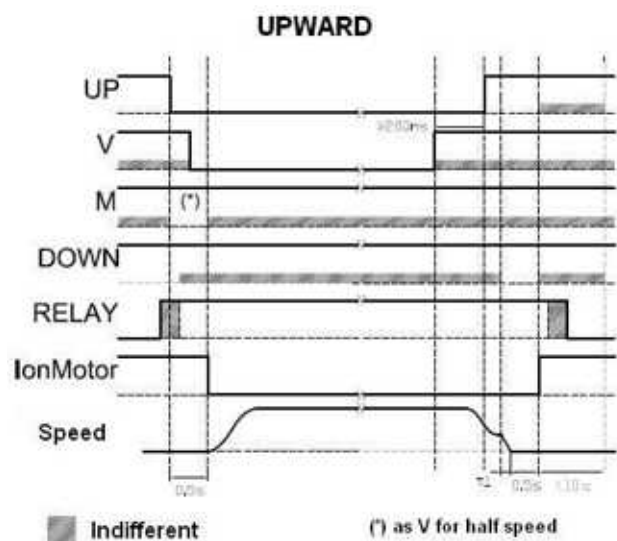

Fig. 6

If the signal UP goes down when V is still active, the MED executes the S-shape until the positioning speed followed from the t1 slope to stop the motor, independently that it is active or not less the recovery space function. Also in this case the motor power relays must not be opened. If the motor power relays are opened and closed when the commands are present, the MED goes in error A02=ICC-IPM.



**CAUTION:** Close the motor power relays before closing the contacts used for the UP command and to determine the car movement speed (M/V). Release the motor power relays with a delay of 2 seconds to the release of the above signals. To delay the motor power relay opening, you can use the information coming from the signal *IonMotor* (see the manual “Simplified installation instructions for the drive MED-UP with encoder” – page 4/15). Anyway in this case, for safety reasons, release the motor power relays within 5 seconds to the release of the contact used for the UP command.



**WARNING:** In case an emergency occurs, delay the opening of the motor power relays from the opening of the emergency chain at least 1 s or as much as possible.



WARNING: Enable the MED to run the motor upward by the ENABLE signal. At the end of the mission, disable the MED by the ENABLE signal. Delay the opening of the ENABLE contact from the opening of the motor power relays (see page 6/14).



WARNING: **When the safety chain occurs**, open the ENABLE contact in advance from the opening of the motor power relays (see page 6/14).

#### In case of failure

- internal to the MED: the motor stops instantaneously and after 10 seconds approximately it starts again in agreement to the new commands. Only in case of thermal protection of the IGBT module (code A01=THP-HTS), before stopping, it will slow down; the MED is restored automatically only when IGBT power module cools. In the event that the failure code is A12=THP-IPM the MED will stop and wait to cool down for the reset;
- external: if UP goes down and returns, the MED stops the motor and starts it again in agreement to the new command when the motor is stopped, however not before 10 s. If the motor power relays open and the commands are still present, the MED will go on in agreement to the commands, but the car will be stopped instantaneously. If in this conditions the motor power relays get closed → fault A02=ICC-IPM occurs.

## **Downward (at releveling, maintenance and maximum speed)**

The MED is not intended to manage the car movement in downward direction; for it please refer to the hydraulic power unit handbook directly supplied by its manufacturer.

## **Solenoid valve power supply**

The MED is not intended for the power supply of the solenoid valves mounted in the hydraulic unit that must be handled totally by the lift control panel. To manage them, refer to the manual *"Simplified installation instructions for the drive MED-UP with encoder"* – pages 13/15 and 14/15.

## **Sensor to compensate the pump leakage**

If the motor is equipped with the sensor for the compensation of the pump leakage, this one has to be connected to the inverter to the terminals labelled "CT Sensor", in order to maintain the upward speed of the car insensitive to variations in load and oil temperature of the hydraulic power unit. To connect the sensor, please refer to the manual *"Simplified installation instructions for the drive MED-UP with encoder"* – page 7/15.



CAUTION: Do not use the inverter terminals labelled "CT Sensor", if the motor is not equipped with the sensor for the compensation of the pump leakage.



CAUTION: The motor with the sensor for the compensation of the pump leakage is equipped with two conductors of white color marked "SENS. CT".



ELMO S.R.L.

Viale Certosa, 8/B – Pavia (Italy)

www.elmoitaly.com

# PROGRAMMING MANUAL

# MED-UP

# WITH ENCODER

(for part N. “U0W(g).....”)





# IMPORTANT OPERATING AND SAFETY INSTRUCTIONS



## WARNING: DANGER OF ELECTRICAL DISCHARGE

THE MED IS UNDER DANGEROUS VOLTAGES AND CONTAINS PARTS IN MOVEMENTS (FAN).

### 1) WARNING

TO GUARANTEE THE SAFETY OF THE PERSONS IT IS OBLIGATORY TO **SUPPLY WITH AN ACCURATE GROUNDING THE MED** AND THE SYSTEM OF WHICH IT IS PART IN ORDER TO DISPERSE EFFICIENTLY IN THE GROUND THE ELECTRICAL CURRENTS THAT CAN BE IN CASE OF FAILURE. THAT CONCURS TO LOWER TO SAFETY LEVELS THE VALUES OF THE CONTACT VOLTAGES.

### 2) WARNING

THE MED CONTAINS FILTER CAPACITORS IN THE DC SUPPLY CIRCUIT. AFTER TO HAVE SWITCHED OFF THE MED, IN IT IS STILL PRESENT HIGH VOLTAGE; IT IS NECESSARY TO **WAIT 5 MINUTES** BEFORE APPROACHING THE MED, ONCE SWITCHED OFF.

### 3) WARNING

FOR A CORRECT VENTILATION OF THE MED IT IS NECESSARY TO LEAVE APPROXIMATELY 100 MILLIMETERS OF FREE SPACE OVER AND UNDER THE MED AND 100 MILLIMETERS FROM EACH SIDE. NOT RESPECTING SUCH DISPOSITION CAN CAUSE A DANGEROUS MED OVERHEATING.

### 4) WARNINGS

- A WRONG CONNECTION OF THE MED CAN DESTROY OR DAMAGE IT.
- INSTALLATION, CONNECTION TO THE POWER SUPPLY, COMMISSIONING AND MAINTENANCE OPERATIONS OF THE MED MAY ONLY BE PERFORMED BY QUALIFIED SERVICE PERSONNEL, WHICH IS ABLE TO OPERATE ON LIVE VOLTAGE PARTS AND ON MECHANICAL MOVING PARTS! THE RELEVANT REGULATIONS, OPERATING AND SAFETY INSTRUCTIONS MUST BE OBSERVED. IGNORE THE SAFETY INSTRUCTIONS COULD CAUSE INJURY!
- THE CORRECT OPERATION OF THE MED PRESUPPOSES AN ADEQUATE TRANSPORT, INSTALLATION, ASSEMBLY AND MAINTENANCE.
- THE INSTALLATION OF THE MED IS MADE UNDER THE RESPONSIBILITY OF THE OPERATOR, SUCH INSTALLATION MUST BE CARRIED OUT ACCORDING TO THE SAFETY PRESCRIPTION.
- THE CONNECTIONS TO THE POWER SUPPLY MUST BE MADE WITH A PROPER SIZING OF THE LEADS AND OF THE RELATED SHORT-CIRCUIT+OVERLOAD PROTECTION DEVICES IN ORDER TO GUARANTEE A SAFETY OPERATION.
- DO NOT CONNECT CAPACITORS ON MOTOR SIDE OF THE DRIVER BUT ONLY INDUCTIVE LOADS.
- DO NOT MOUNT THE MED WITHOUT PROTECTIONS AGAINST BAD WEATHER, BUT PROVIDE A PROPER PROTECTION OR COVER.
- BE SURE THAT THE CONNECTION OF THE SIGNAL SHIELD IS CORRECTLY MADE.
- PREFERABLY USE THE MED KEYBOARD ONLY WITH THE STOPPED MOTOR AND IN ABSENCE OF EXTERNAL COMMAND.
- THE MED GIVES AN OUTPUT VOLTAGE EQUAL TO 400 V. **THE MOTOR MUST BE IN DELTA (Δ) OR STAR (Y) CONNECTION, ACCORDING TO THE OUTPUT VOLTAGE OF THE MED.**

ABOUT THE CONNECTION, PLS. CONSULT THE WIRING DIAGRAM SUPPLIED WITH THE MOTOR BY THE MOTOR MANUFACTURER.

**5) IMPORTANT CAUTION**

THE MED IS SUPPLIED WITH AN **EMC** FILTER, IN ACCORDANCE TO THE ELECTROMAGNETIC STANDARD (EN12015, EN12016). BECAUSE OF FILTER, A **300 mA "B" TYPE** (ALTERNATIVELY "A" TYPE) RCD DEVICE (RESIDUAL CURRENT DEVICE OR DIFFERENTIAL RELAY) MUST BE USED. DO NOT EMPLOY ANY DIFFERENT TYPE (IN TERMS OF CLASS AND/OR SENSITIVITY) OF RCD DEVICE TO AVOID AN UNDESIRE OPERATION.

**6) IMPORTANT CAUTION**

BE SURE THAT THE GROUND OF THE MED IS CORRECTLY CONNECTED TO THE EARTH. **DO NOT INSTALL THE MED UNGROUNDED**. THE EARTH CONNECTION MUST BE DONE ACCORDINGLY TO THE ELECTRICAL STANDARDS.

**7) DESTINATION OF THE PRESENT MANUAL**

THE PRESENT MANUAL IS DEDICATED TO A QUALIFIED STAFF WITH AN ADEGUATE KNOWLEDGE ON THE USE OF A VARIABLE SPEED ELECTRICAL DRIVES. A WRONG PROGRAMMING CAUSES AN UNSTABLE AND DANGEROUS OPERATIONS OF THE SYSTEM.



CAUTION: DISTINGUISH THE SIGNAL "UP" FROM KEY "UP". THE FIRST ONE IS AN ELECTRICAL SIGNAL GIVEN TO THE TERMINAL BLOCK COMMANDS, THE SECOND ONE ALLOWS, TOGETHER WITH THE KEY "DOWN", THE MOVEMENT IN THE MED PROGRAMMING MENU.



CAUTION: THE INFORMATION CONTAINED HEREIN MAY BE MODIFIED WITHOUT NOTICE. **MAKE SURE YOU HAVE THE LATEST VERSION OF THIS DOCUMENT.**



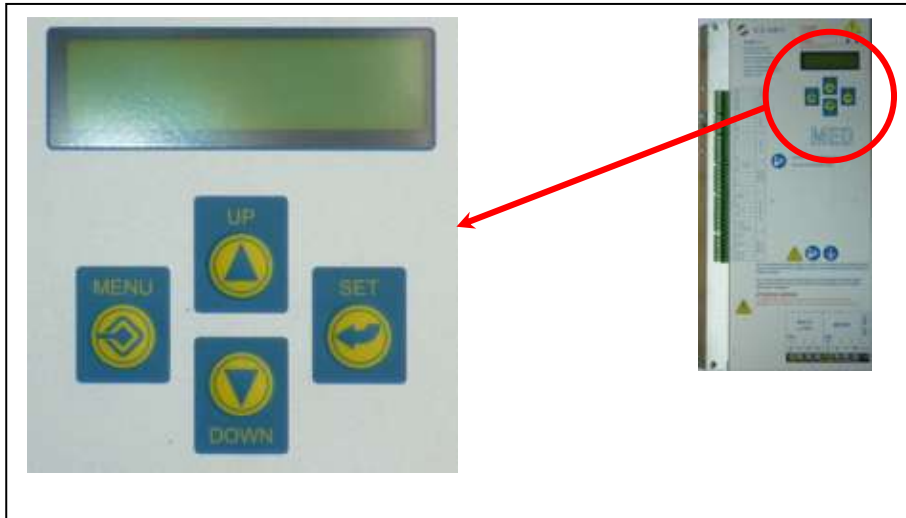

# The keyboard and the MENU

The driver MED is equipped with a keyboard having four push-buttons placed right under the display that allows also to personalize the parameter setting.

The display is a two lines of alphanumeric text type. It shows the number and descriptions of the menu or the value of the visualized parameter or function.



The functions of every key are following:

	<b>MENU</b>	Key to access to one of the seven menu, to output from the function / parameter selected and to return to the main menu.
	<b>SET</b>	Key to selection feature / function you want, to access and exit the edit mode of the function / parameter selected.
	<b>UP</b>	Key to move upwards in the same menu. In the numerical choice, to every pressure, the value increases of the minimal step.
	<b>DOWN</b>	Key to move downwards in the same menu. In the numerical choice, to every pressure, the value decreases of the minimal step.



**WARNING:** Preferably work on the keyboard only when the motor is stopped and in the absence of commands to the MED. If you work while the MED are running or while the motor is running, the keyboard may stop responding. To reset the keyboard, turn off and on again only when the MED LEDs above the display are off.

# Release of the keyboard

The keyboard of the MED is normally locked. In order to enter to the first level menu press the keys DOWN and SET simultaneously until the MED emits a sound. If no key is pressed within 30 s the keyboard blocks newly. Repeat the procedure in order to unlock it newly. The keyboard gets blocked always automatically and the menu jumps to the main one if no key is pressed within 30 s.

## First level menu

Released the keyboard the first level menu it is shown. The fig. 1 shows this menu and it explains the functions. Press UP and DOWN keys in order to move in the menu.

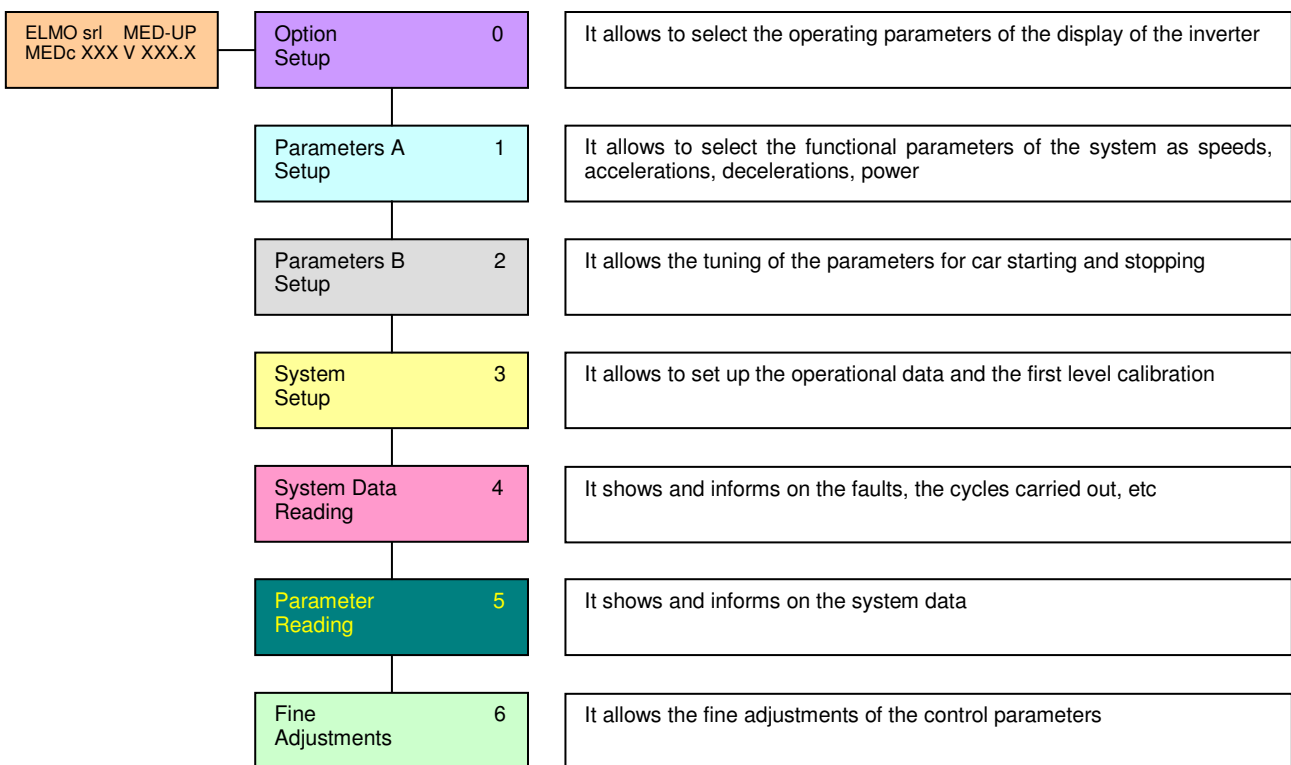

Fig. 1

The number that appears in the menu indicates the level of the menu in which it is found to be.

## 0 Option setup

The menu allows you to select the operating parameters of the inverter display. The menu is structured as in fig. 0.1.

To modify the value of a parameter, select in the menu the parameter of interest and press the SET button to enter the edit mode: use the UP or DOWN button to set the parameter to the desired value. Confirm the value with the SET key and press MENU key to exit.



**CAUTION:** When you are in edit mode, the data of selected parameter is flashing. Press the SET button to confirm your selection or press the MENU key to exit.

**CAUTION:** If the buzzer of the MED is enabled (parameter 04 = ON), a repeated series of five or more consecutive beeps indicate that:



- when you press the UP or DOWN key in edit mode, you are setting a parameter beyond the range allowed;
- when you press UP key, you are already viewing the first menu or the first parameter of the menu;
- when you press DOWN key, you are already viewing the last menu or the last parameter of the menu.

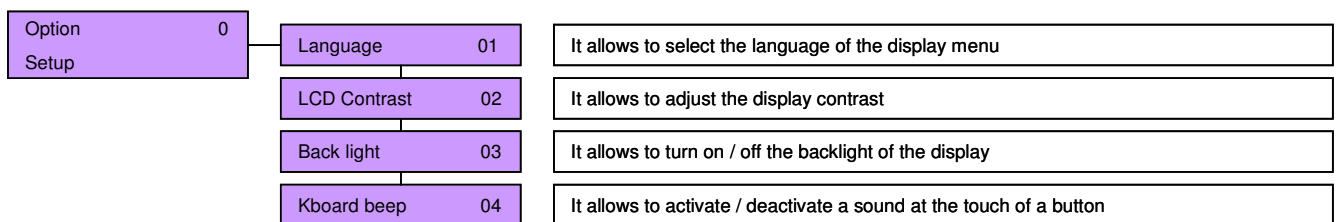

Fig. 0.1

The following describes the meaning of each parameter.

## 01 Language

This parameter allows you to choose the language of every message on the display. The possible values are reported in fig. 01.1. The default language is English.

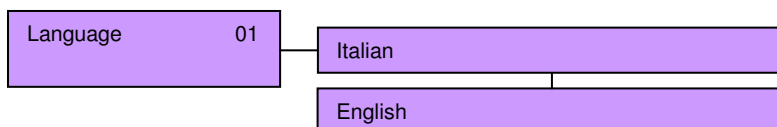

Fig. 01.1

## 02 LCD contrast

This parameter allows you to adjust the contrast of every message on the display. The possible values are reported in fig. 02.1. The nominal value is 60%.

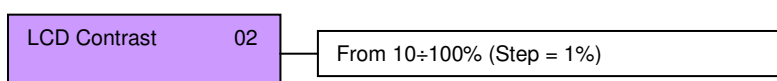

Fig. 02.1

## 03 Back light

This parameter allows the management of the backlight of the display. The possible values are reported in fig. 03.1. The nominal value is AUTO.

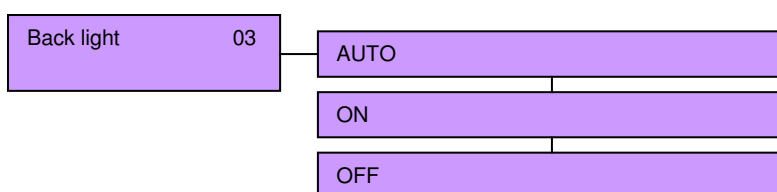

Fig. 03.1

<b>AUTO</b>	The backlight of the display is activated by pressing a button and turns off automatically after a preset time.
<b>ON</b>	The backlight of the display is always active.
<b>OFF</b>	The backlight of the display is always off.

## 04 Kboard beep

This parameter allows you to enable or disable the sound from the buzzer of the MED pressing any key or the occurrence of any event.

The possible values are reported in fig. 04.1. The nominal value is ON.

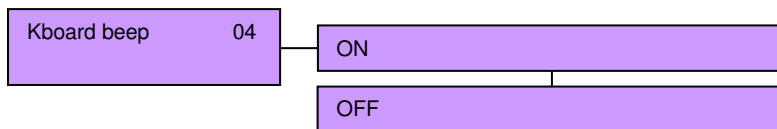

Fig. 04.1

<b>ON</b>	At the press of any button or the occurrence of any event the buzzer of the MED will sound.
<b>OFF</b>	The buzzer of the MED emits a sound only when you simultaneously press the DOWN and SET keys to release the keyboard.

# 1 Parameters A setup

The menu allows you to select the speed, acceleration / deceleration and engaged power (type A parameters); the menu is reported in fig. 1.1. The limits of the values are indicated in the description on the side.

To modify the value of a parameter, select in the menu the parameter of interest and press the SET button to enter the edit mode: use the UP or DOWN button to set the parameter to the desired value. Confirm the value with the SET key and press MENU key to exit.



**CAUTION:** When you are in edit mode, the data of selected parameter is flashing. Press the SET button to confirm your selection or press the MENU key to exit.

**CAUTION:** If the buzzer of the MED is enabled (parameter 04 = ON), a repeated series of five or more consecutive beeps indicate that:



- when you press the UP or DOWN key in edit mode, you are setting a parameter beyond the range allowed;
- when you press UP key, you are already viewing the first menu or the first parameter of the menu;
- when you press DOWN key, you are already viewing the last menu or the last parameter of the menu.

Parameters A Setup	1	UP Pos/Relev.	10	Upward positioning and relevering speed. Values: 200÷ 800 rpm (step = 10 rpm)
		UP Half Spd	11	Upward half speed at steady state. Values: 1000÷3000 rpm (step = 50 rpm)
		UP Maint. Spd	12	Upward maintenance speed. Values: 600÷2400 rpm (step = 50 rpm)
		UP Max Spd	13	Upward maximum speed at steady state. Values: 1000÷4000 rpm (step = 50 rpm)
		UP Acc. Time	14	Upward acceleration time. Values: 0.1÷5 s (step = 0.05 s)
		UP Dec. Time	15	Upward deceleration time. Values: 0.1÷5 s (step = 0.05 s)
		Max Power-IN	16	Maximum engaged power. Values: 1÷50 kW (step = 1 kW)
		Parameter	17	Function not allowed. It is used for other versions of MED
		Parameter	18	Reserved. <b>DO NOT USE</b>
		Parameter	19	Function not allowed. It is used for other versions of MED
		Parameter	116	Function not allowed. It is used for other versions of MED
		Parameter	117	Function not allowed. It is used for other versions of MED
		Parameter	118	Function not allowed. It is used for other versions of MED
	Parameter	119	Function not allowed. It is used for other versions of MED	

Fig. 1.1



The meaning of the various parameters is shown in fig. 1.2.

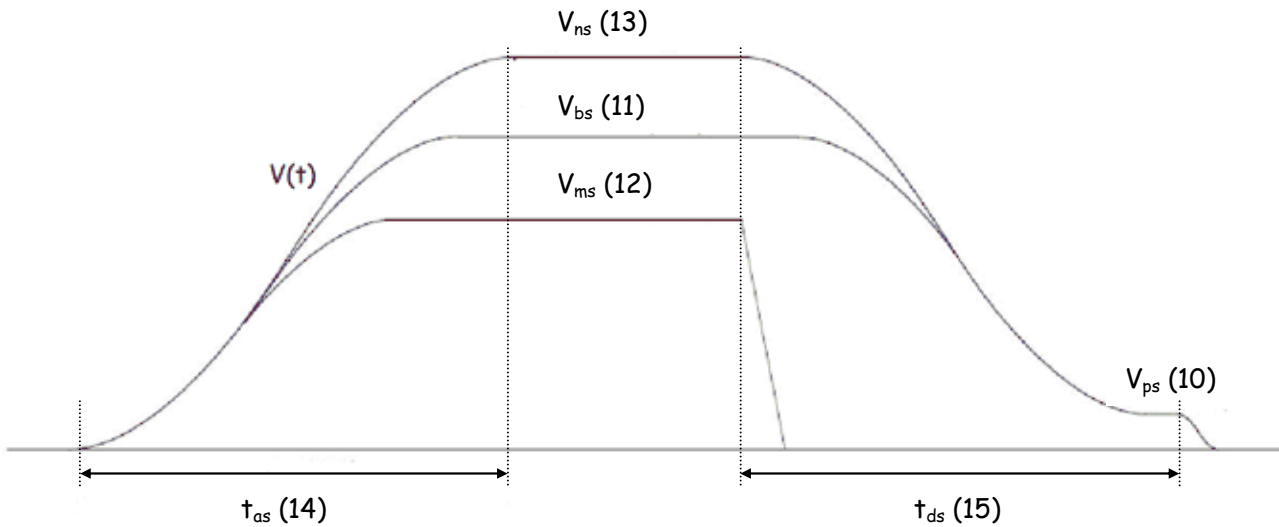

Fig. 1.2



CAUTION: The MED is equipped with a 50 Hz motor (60 Hz on request) and the hydraulic power unit is rated for an upward nominal speed equal to 2750 rpm (3300 rpm when you use a 60 Hz motor). **Modify the above value (parameter 13) only when absolutely necessary and with the consent of the dealer.**



CAUTION: To enable the proper functioning of the system, the value of each parameter may be automatically limited to a min or max value different from what has been shown in fig. 1.1.



CAUTION: **The drive does not manage the movement of the cabin in downward direction.** Therefore to change the downward speed and downward acceleration / deceleration time, please refer to the manual of the hydraulic power unit supplied directly from its manufacturer.

## 2 Parameters B setup

The menu enters in the set of the parameters for the fine adjustments (type B parameters).



CAUTION: Enter in this menu only if it is necessary and if you are very expert skilled.



CAUTION: The modification of the parameters of this menu can affect the correct functionality of the elevator. Modify the parameters only after having read the following instructions carefully.



CAUTION: Before modifying any parameter, annotate the previous parameters so that it can be returned to the previous values.

The menu is structured as in fig. 2.1. To modify the value of a parameter, select in the menu the parameter of interest and press the SET button to enter the edit mode: use the UP or DOWN button to set the parameter to the desired value. Confirm the value with the SET key and press MENU key to exit.



CAUTION: When you are in edit mode, the data of selected parameter is flashing. Press the SET button to confirm your selection or press the MENU key to exit.

CAUTION: If the buzzer of the MED is enabled (parameter 04 = ON), a repeated series of five or more consecutive beeps indicate that:



- when you press the UP or DOWN key in edit mode, you are setting a parameter beyond the range allowed;
- when you press UP key, you are already viewing the first menu or the first parameter of the menu;
- when you press DOWN key, you are already viewing the last menu or the last parameter of the menu.



CAUTION: To enable the proper functioning of the system, the value of each parameter may be automatically limited to a min or max value different from what has been shown in the following pages.

In the following each parameter is described for a correct tune of it.

Parameters B Setup	2	UP Prs Slope	20	Function not allowed. It is used for other versions of MED
		UP Start Spd	21	Function not allowed. It is used for other versions of MED
		UP Delay Tm	22	Function not allowed. It is used for other versions of MED
		UP Spd Slope	23	Function not allowed. It is used for other versions of MED
		UP Lev. Time	24	Time for the positioning speed to go to zero (upward direction)
		Parameter	25	Function not allowed. It is used for other versions of MED
		Parameter	26	Function not allowed. It is used for other versions of MED
		Parameter	27	Function not allowed. It is used for other versions of MED
		Parameter	28	Function not allowed. It is used for other versions of MED
		Parameter	29	Function not allowed. It is used for other versions of MED
		Parameter	224	Function not allowed. It is used for other versions of MED
		Parameter	225	Function not allowed. It is used for other versions of MED
		Parameter	226	Function not allowed. It is used for other versions of MED
		Parameter	227	Function not allowed. It is used for other versions of MED
		Parameter	228	Function not allowed. It is used for other versions of MED
	Parameter	229	Function not allowed. It is used for other versions of MED	

Fig. 2.1

## 20 UP pressure slope

Function not allowed. It is used for other versions of MED.

## 21 UP start speed

Function not allowed. It is used for other versions of MED.

## 22 UP delay time

Function not allowed. It is used for other versions of MED.

## 23 UP speed slope

Function not allowed. It is used for other versions of MED.

## 24 UP levelling time

This parameter allows to change the time for the positioning speed in upward direction to go from the selected value to zero.

The possible values are reported in fig. 24.1. Increasing with UP the value the time is increased, while with DOWN the time is reduced. The nominal value is 14.

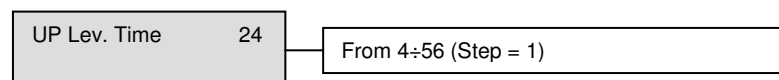

Fig. 24.1



**CAUTION:** Set the value at the minimum comfortable one. Move the floor magnets accordingly for a precise positioning of the car.

## **Parameters 25, 26, 27, 28, 29, 224, 225, 226, 227, 228 and 229**

Functions not allowed. They are used for other versions of MED.

## 3 System setup

The menu enters in the essential set of the operational and calibration parameters of first level and is structured like in fig. 3.1.

To modify the value of a parameter, select in the menu the parameter of interest and press the SET button to enter the edit mode: use the UP or DOWN button to set the parameter to the desired value. Confirm the value with the SET key and press MENU key to exit.



**CAUTION:** When you are in edit mode, the data of selected parameter is flashing. Press the SET button to confirm your selection or press the MENU key to exit.

**CAUTION:** If the buzzer of the MED is enabled (parameter 04 = ON), a repeated series of five or more consecutive beeps indicate that:



- when you press the UP or DOWN key in edit mode, you are setting a parameter beyond the range allowed;
- when you press UP key, you are already viewing the first menu or the first parameter of the menu;
- when you press DOWN key, you are already viewing the last menu or the last parameter of the menu.

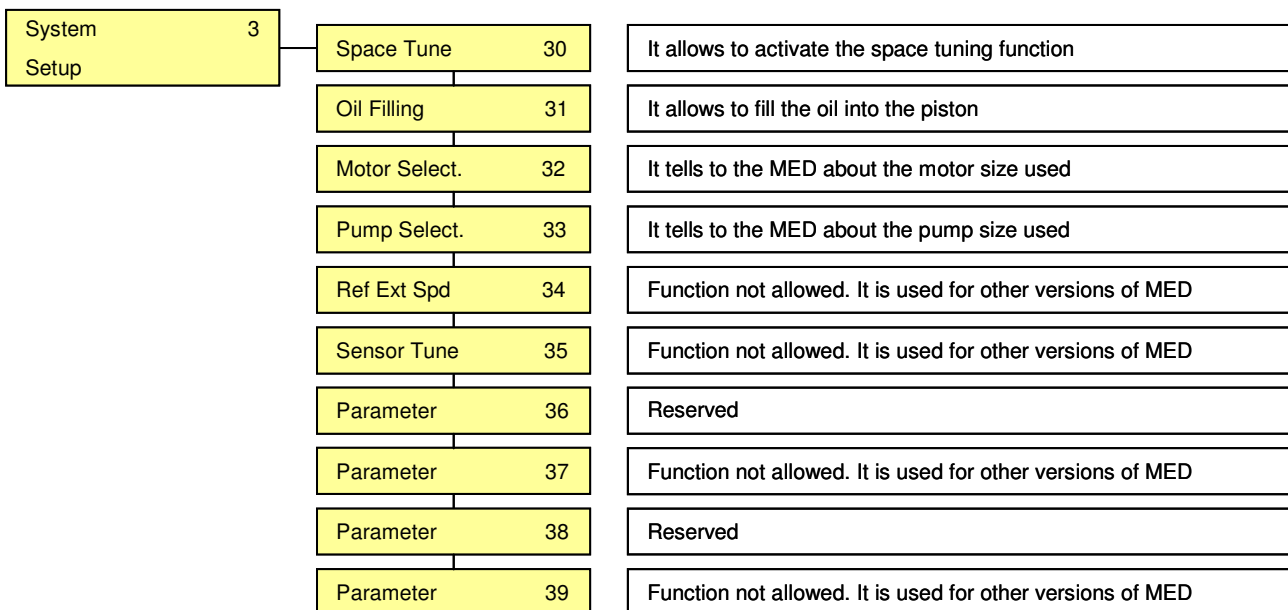

Fig. 3.1

In the following a description of every menu in its function and the necessary operations will be made.

## 30 Space tune

This function allows to activate or deactivate the function of dynamic space recovery.

The menu has two states, as shown in fig. 30.1. The MED is delivered with the function in OFF state.

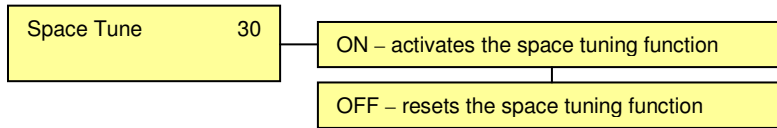

Fig. 30.1

The function is activated/inactivated pressing the key SET.



CAUTION: activate the function only at the end of the system installation. The space tuning must be selected only when the floor magnets and deceleration magnets are definitively positioned.



CAUTION: reset parameters number 155 and 156 to the factory (see pages 47/49 and 48/49 of this manual) before activating the space tune function.



CAUTION: it is advised to position all the deceleration magnets at the same distance from the levelling magnets to obtain a precise and uniform space tuning (see the manual "*Simplified installation instructions for the drive MED-UP with encoder*").



CAUTION: Space tuning must be activated preferably with cold oil.

<b>OFF</b>	The system slows down when V signal goes OFF, executes the deceleration from the steady speed to the positioning speed according to the programmed acceleration/deceleration times and continues the race at the positioning speed until the stop signal goes OFF.
<b>ON</b>	The function of recovery of the spaces is active. The MED completes the first learning race. It measures the space between the deceleration magnet and the stop magnets and saves the smaller value between the floors. It recovers in the second race the saved positioning space.

The MED recovers to the smaller deceleration space between the floor distances of upward. In case a releveling occurs after the deceleration, the MED reduces the saved space of the measured releveling space.

If the function is in OFF state, the MED resets the counters and saves the spaces at the first reactivation.

If speeds, deceleration time are modified, the MED resets the counter automatically and reads again the spaces in the successive race.

If the space recovery gets off of tune, is advised to reset and reactivate the function for a new space adjustment.

The function temporary is inactive when:

- the MED is powered ON
- after a maintenance race
- after a fault comes up
- if the motor power relays are opened before that the MED stops the motor
- the ENABLE signal goes OFF during a race while the motor is running and it is energized

and gets active automatically after the first two race for direction.



CAUTION: space tuning will always be turned off if motor power relays are opened before that the MED stops the motor.



CAUTION: do not move any floor magnet or deceleration magnet while the space tuning is ON. If the magnets are moved, reset and reactivate the function for a new space reading.

## 31 Oil filling

The MED allows the system oil filling in a simple way.

Selecting ON this function the system can easily be filled up giving UP command. The MED stops the motor when the UP command is released and restarts if it is again activated. During oil filling procedure, the V and M commands have no effect.

The menu has two states, like shown in fig. 31.1. Every state must be confirmed pressing key SET.

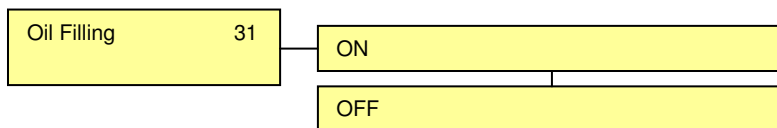

Fig. 31.1

Set the function to OFF and confirm with the SET button at the end of this operation and return to the main menu.



CAUTION: be sure that the air is completely removed from the piston and the hydraulic circuit. The air presence makes the system elastic and the car can oscillate. The MED cannot compensate the oscillations due to the air presence. Moreover the starting shows an higher jerk.



## 32 Motor selection

It is required to inform the MED about the size of the motor assembled on the hydraulic power unit. In such a way the MED can have the best adaption to the system. The planned motors are indicated in fig. 32.1.

Move into the menu with keys UP and DOWN. Confirm the selection with SET.

Motor Select. 32	4,4 kW, 6 kW, 7,7 kW, 9,5 kW, 11 kW, 12 kW, 13 kW, 14,7 kW, 16 kW, 18,4 kW, 20 kW, 22,1 kW, 24 kW, 29 kW, 33 kW, 40 kW, 47 kW - 50HzN
	4,4 kW, 6 kW, 7,7 kW, 9,5 kW, 11 kW, 12 kW, 13 kW, 14,7 kW, 16 kW, 18,4 kW, 20 kW, 22,1 kW, 24 kW, 29 kW, 33 kW - 50HzV
	4,4 kW, 6 kW, 7,5 kW, 9,5 kW, 11 kW, 12 kW, 13 kW, 15 kW, 18,5 kW, 22,1 kW, 24 kW, 29 kW - 60HzN
	1,1 kW, 1,5 kW, 2,2 kW, 3 kW, 4 kW, 5,5 kW, 7,5 kW, 9,2 kW, 11 kW - 50HzHE

Fig. 32.1



**CAUTION: select the size of the motor by paying attention to its frequency, to the fact that it is a traditional submersible motor or external high efficiency motor and the presence or absence of the flywheel (50HzN = 50 Hz motor without flywheel, 50HzV = 50 Hz motor with flywheel, 60HzN = 60 Hz motor without flywheel, 50HzHE = 50 Hz external high efficiency motor).**

## 33 Pump selection

It is required to inform the MED about the size of the pump assembled on the hydraulic power unit. In such a way the MED can have the best adaption to the system. The planned pumps are indicated in fig. 33.1 (data refer to the nominal flow rate of the pumps at 50 Hz (2750 rpm) as declared from the constructor).

Move into the menu with keys UP and DOWN. Confirm the selection with SET.

Pump Select. 33	55, 75, 100, 125, 150, 180, 210, 250, 270, 300, 330, 380, 440, 500; S55, S75, S100, S125, S150, S180, S210, S250, S270, S300, S330, S380, S440, S500
-----------------	---

Fig. 33.1



**CAUTION: do not select the pump type "S" (S55, S75, S100, S125, S150, S180, S210, S250, S270, S300, S330, S380, S440, S500) used for future implementations.**

## **34 External speed**

Function not allowed. It is used for other versions of MED.

## **35 Sensor tune**

Function not allowed. It is used for other versions of MED.

## **Parameter 36**

Reserved. **DO NOT USE.**

## **Parameter 37**

Function not allowed. It is used for other versions of MED.

## **Parameter 38**

Reserved. **DO NOT USE.**

## **Parameter 39**

Function not allowed. It is used for other versions of MED.

# 4 System data reading

Through this menu it is possible to read on the MED the operating information or eventually the failure that have been taken place. The menu is reading only and it is not possible to reset the data.

Fig. 4.1 shows the structure of the menu.

When you are in this menu, press the SET button to go to the next screen, then use the UP or DOWN keys to display the desired parameter value. Press MENU to exit.



CAUTION: If the buzzer of the MED is enabled (parameter 04 = ON), a repeated series of five or more consecutive beeps indicate that:

- when you press UP key, you are already viewing the first menu or the first parameter of the menu;
- when you press DOWN key, you are already viewing the last menu or the last parameter of the menu.

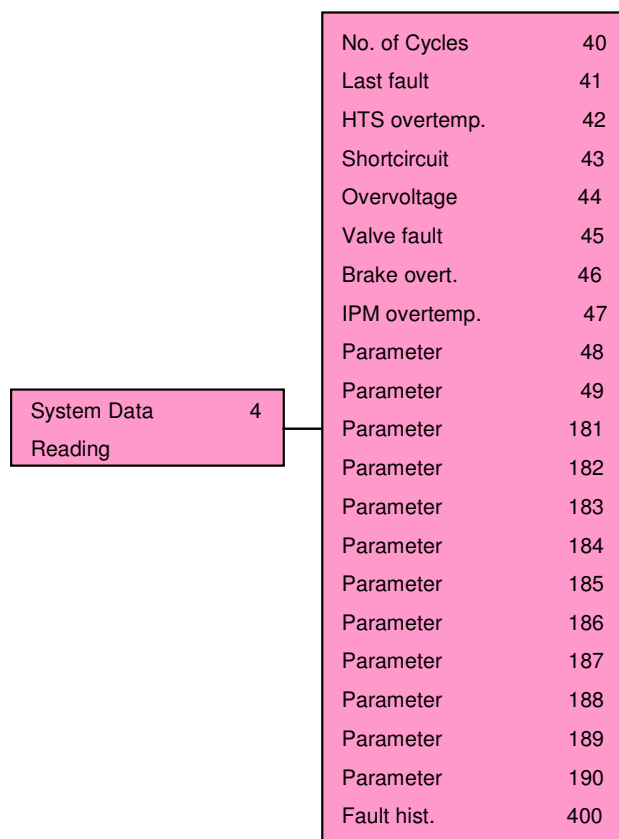

Fig. 4.1

In the following table the meaning of every indicated data is reported.

#	Reading	Description
40	Number of cycles	Shows the number of upward cycles carried out from the MED
41	Last fault	Shows the code of the last occurred fault
42	Heatsink overtemperature	Indicates how many times the system has gone in A01=THP-HTS fault
43	Shortcircuit	Indicates how many times the system has gone in A02=ICC-IPM fault
44	Overvoltage	Indicates how many times the system has gone in A03=OVE-BUS fault
45	Valve fault	Indicates how many times the system has gone in A04=EVD KO fault
46	Brake overtemperature	Indicates how many times the system has gone in A07=THP-CLP fault
47	IPM overtemperature	Indicates how many times the system has gone in A12=THP-IPM fault
48	Parameter 48	Reporting is not active. For future implementations
49	Parameter 49	Reporting is not active. For future implementations
181	Parameter 181	Reporting is not active. For future implementations
182	Parameter 182	Reporting is not active. For future implementations
183	Parameter 183	Reporting is not active. For future implementations
184	Parameter 184	Reporting is not active. For future implementations
185	Parameter 185	Reporting is not active. For future implementations
186	Parameter 186	Reporting is not active. For future implementations
187	Parameter 187	Reporting is not active. For future implementations
188	Parameter 188	Reporting is not active. For future implementations
189	Parameter 189	Reporting is not active. For future implementations
190	Parameter 190	Reporting is not active. For future implementations
400	Fault history	Shows the succession of all the possible failures that have occurred

## Error codes

In case of a failure or an anomaly on the MED, the display visualizes the code of the failure. To unblock the MED, press keys UP and DOWN simultaneously (manual reset), or wait about 10 s for automatic reset except when it is indicated that it is necessary to restart the MED (switching OFF and ON). For failures A01=THP-HTS, A07=THP-CLP and A12=THP-IPM, the MED is reset automatically after it has cooled.

The automatic reset of the errors occurs in all cases except during oil filling procedure. In this case you need to implement the manual reset of the error.



**WARNING:** in case of restart of the MED wait the complete discharge of the MED indicated from the power off of the LEDs over the display.

After that the MED has been reset it is ready for the normal operation. Verify however the type of the occurred failure and follow the following instructions in order to make sure that the cause of the failure has been removed.

The MED informs about the failure through the display and through the signal R/F on the pin 2 from upside of the connector MOTOR SIGNALS: in absence of failure the signal is OFF or ZERO and it goes ON when the failure occurs. The signal is an Open Collector: connect a resistor to a voltage reference (see manual “Simplified installation instructions for the drive MED-UP with encoder”).

For some failures the MED informs about the type of anomaly through the signal R/F or the signal  $I_{MOT}/THP$  on the pin 2 and pin 4 from upside of the connector MOTOR SIGNALS (see the following description of every failure).

In the following table the meaning of every number code is reported.

<b>Error code</b>	<b>Alarm</b>
Fault A01=THP-HTS	MED overtemperature
Fault A02=ICC-IPM	Shortcircuit
Fault A03=OVE-BUS	BUS overvoltage
Fault A04=EVD-KO	Reporting is not active. For future implementations
Fault A05=MOTOR-?-	Motor not connected
Fault A07=THP-CLP	Internal resistor overtemperature
Fault A10=PHL-LINE	MED supplied in single phase
Fault A11=IMEAS.KO	Current sensors failure
Fault A12=THP-IPM	IGBT thermal protection
Fault A15=UVL-BUS	BUS undervoltage
Fault A18=ENC-KO	Digital speed sensor (ENCODER) failure or not connected
Fault A22=OVC-MOT	Overcurrent
Fault A90=TOUT DSP	DSP timeout – Restart the MED
Fault A91=COM KO	Communication problems while DSP and display are communicating – Restart the MED
Fault A92=COM TOUT	Timeout while DSP and display are communicating – Restart the MED

## FAULT A01=THP-HTS: MED overtemperature

The MED has an internal power module thermal protection that guarantees not overcoming of the maximum permissible temperature from it (see FAULT A12=THP-IPM). Since this protection has the service breakdown, through FAULT A01=THP-HTS it is attempted to complete the race to the closer floor to avoid the stop of the car.

The MED operates without any external information if its temperature remains below 55 °C. In such conditions the signal R/F is 0, the signal  $I_{MOT}/THP$  is 0 and the output current can be up to 130% of nominal, allowing you to adjust the overpressure valve of the hydraulic unit. Reaching 55 °C and up to 70 °C the MED still operates without any restriction, but begins to limit the output current to 100% of the nominal. Between 70 °C and 90 °C the MED limits the output current to approximately 60% of the nominal and the signal R/F remains to 0 while the signal  $I_{MOT}/THP$  becomes square wave signal with a frequency of 10 Hz and duty cycle of 50%. In these conditions the MED works thus limiting the output current but it warns the elevator control panel to stop to the closer floor. At 90 °C the MED stops the race and the signals R/F<sup>(1)</sup> and  $I_{MOT}/THP$  go to 1.

The MED is automatically reactivated when the temperature drops below 80 °C, but it limits the output current again; it begins to provide the rated current of the drive when its temperature drops below 60 °C. When the temperature drops below 45 °C further, the output current from the drive can again reach up to 130% of nominal.

The following tables show the failure functionality.

<b>Temperature</b>	<b>R/F</b>	<b><math>I_{MOT}/THP</math></b>	<b>Action</b>
$\theta < 55\text{ °C}$	0	0	Upward possible with maximum output current equal to 130% of the nominal current
$55\text{ °C} < \theta < 70\text{ °C}$	0	0	Upward possible with maximum output current equal to 100% of the nominal current
$70\text{ °C} < \theta < 90\text{ °C}$	0	50% 10 Hz	Upward possible, but the MED limits the output current to approximately 60% of the nominal current
$\theta > 90\text{ °C}$	1	1	Upward interrupted

Temperature values that set the thermal protection

<b>Temperature</b>	<b>R/F</b>	<b><math>I_{MOT}/THP</math></b>	<b>Action</b>
$\theta < 80\text{ °C}$	→ 0	50% 10 Hz	Upward reactivated, but the MED limits the output current to approximately 60% of the nominal current
$60\text{ °C} < \theta < 80\text{ °C}$	0	50% 10 Hz	Upward possible, but the MED limits the output current to approximately 60% of the nominal current
$45\text{ °C} < \theta < 60\text{ °C}$	0	→ 0	Upward possible with maximum output current equal to 100% of the nominal current
$\theta < 45\text{ °C}$	0	0	Upward possible with maximum output current equal to 130% of the nominal current

Temperature values that reset the thermal protection



**WARNING:** when the MED limits the output current, **the car could move at speed lower than the nominal one and might not go upward in case of overweight**; it could cause a prolonged duration of the mission with a possible intervention of the lift control panel alarm.

#### CAUSES OF THE FAILURE

- The size of the used MED is too small
- The number of run per hour is higher than the designed one (the size of the used MED is too small)
- The load of the car is too high
- High frictions forces due to mechanical or hydraulic problem

<sup>(1)</sup> On demand, the signal R/F can inform about the error code as shown in the following figure.

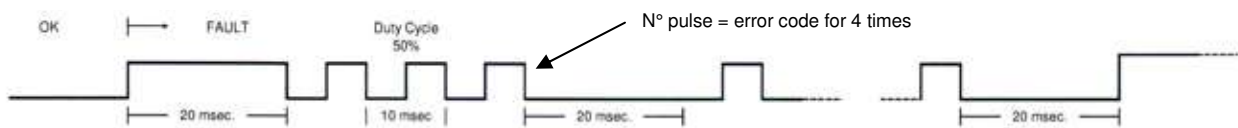

R/F signal during a fault

## FAULT A02=ICC-IPM: Shortcircuit

The MED has a current limiter that controls the current of the motor so that it remains under the nominal current of the MED. Its function limits the current in the case of normal operation of the lift.

In the case of accidental or permanent failure the MED has an active protection against the shortcircuits.

Due to the dangerousness of the failure the protection stops the functionality of the MED after being sure for the existence of the failure. However the MED is restored automatically in order to resume the functionality of the system after 10 s except as described above.



**WARNING:** in case of the failure occurs again after the reset of it, switch off the MED and remove the cause of the problem before switching on the MED again.

If the failure occurs the signal R/F goes to 1 (see note at fault A01=THP-HTS) and the display visualizes the presence of the failure all the time in which the MED is blocked.

#### CAUSES OF THE FAILURE

- IGBT module broken
- Motor wire insulation not in good conditions
- Motor in shortcircuit or with dispersion to ground
- Blocked motor, blocked pump, blocked valve, ...

## **FAULT A03=OVE-BUS: BUS overvoltage**

The MED is protected against the overvoltage on its DC section that could generate during its operation.

Due to the dangerousness of the failure the protection stops the functionality of the MED after being sure for the existence of the failure. However the MED is restored automatically in order to resume the functionality of the system after 10 s except as described above.



**WARNING:** in case of the failure occurs, switch off the MED and remove the cause of the problem before switching on the MED again.

If the failure occurs the signal R/F goes to 1 (see note at fault A01=THP-HTS) and the display visualizes the presence of the failure all the time in which the MED is blocked.

### CAUSES OF THE FAILURE

- Internal braking resistor broken
- IGBT module broken

## **FAULT A04=EVD-KO**

Reporting is not active. For future implementations.

## **FAULT A05=MOTOR-?-: Motor not connected**

Every times that the MED is switched on it checks the presence of the motor through the current that flows in the windings of it. When the motor is supplied (presence of the voltage at the motor terminals) it must be a current that flows in the windings of it. If the current of one phase (or all of them) is zero for a time higher than 10 s, then the MED notices of the lack of connection and informs of the failure.

If the failure occurs the signal R/F goes to 1 (see note at fault A01=THP-HTS) and the display visualizes the presence of the failure all the time in which the MED is blocked. The MED is restored automatically in order to resume the functionality of the system after 10 s except as described above.

### CAUSES OF THE FAILURE

- Contactors/relays between the MED and the motor not connected or broken
- Motor not connected



## **FAULT A07=THP-CLP: Internal resistor overtemperature**

The MED is internally equipped with a resistor which has a thermal sensor, to avoid an excessive overheating of it. The intervention of this failure will stop the car.

Due to the dangerousness of the failure the protection stops the functionality of the MED.



**WARNING:** if this failure occurs, contact your dealer.

If the failure occurs the signal R/F goes to 1 (see note at fault A01=THP-HTS) and the display visualizes the presence of the failure all the time in which the MED is blocked. The MED is restored automatically only when the braking resistor cools.

### CAUSES OF THE FAILURE

- Internal resistor not suitable or insufficient
- MED size not correct or too small

## **FAULT A10=PHL-LINE: MED supplied in single phase**

It can happen due to a failure that the MED is supplied in single phase rather than three phase. In this circumstance the MED can work for very short time and with low loads, although it is very dangerous situation.

The behaviour that comes from this failure is a very high noise and strong vibrations of the car.



**WARNING:** in case of the failure occurs, switch off the MED and remove the cause of the problem before switching on the MED again.

If the failure occurs the signal R/F goes to 1 (see note at fault A01=THP-HTS) and the display visualizes the presence of the failure all the time in which the MED is blocked. The MED is restored automatically in order to resume the functionality of the system after 10 s except as described above.

### CAUSES OF THE FAILURE

- Power relay upfront the MED broken
- Supply wires not connected or interrupted
- EMC/EMI filter broken
- MED internal failure.



**WARNING:** The cooling fan inside the MED could not work properly with consequent thermal protection problems.

## FAULT A11=IMEAS.KO: Current sensors failure

The MED measures the output current from the drive for the corrected operation of the system. In the case that the signals coming from the current sensors are wrong or absent, the MED marks the failure and interrupts its functionality.

Due to the dangerousness of the failure the protection stops the functionality of the MED after being sure for the existence of the failure. However the MED is restored automatically in order to resume the functionality of the system after 10 s except as described above.

If the failure occurs the signal R/F goes to 1 (see note at fault A01=THP-HTS) and the display visualizes the presence of the failure all the time in which the MED is blocked.

### CAUSES OF THE FAILURE

- MED is supplied in single phase rather than three phase
- Current sensors out of order
- Current sensor interface out of order

## FAULT A12=THP-IPM: IGBT thermal protection

The MED has a internal thermal protection for the power module that guarantees not to overcome the maximum permissible temperature from it.

In the case that this failure occurs the MED loses its functionality until the internal IGBT temperature returns to compatible values for the corrected operation.

If the failure occurs the signal R/F goes to 1 (see note at fault A01=THP-HTS) and the display visualizes the presence of the failure all the time in which the MED is blocked. The MED is restored automatically only when IGBT power module cools.



**WARNING:** since the MED has an internal control (see fault A01=THP-HTS) that prevents to reach the conditions of this failure, in case failure occurs call your dealer.

### CAUSES OF THE FAILURE

- The size of the used MED is too small
- The number of run per hour is higher than the designed one (the size of the used MED is too small)
- The load of the car is too high
- High frictions forces due to mechanical or hydraulic problem

## **FAULT A15=UVL-BUS: BUS undervoltage**

The MED tests the voltage on the DC section is not less than a threshold that could affect corrected operation of the system.

Due to the dangerousness of the failure the protection stops the functionality of the MED after being sure for the existence of the failure. However the MED is restored automatically in order to resume the functionality of the system after 10 s except as described above.



**WARNING:** in case of the failure occurs, switch off the MED and remove the cause of the problem before switching on the MED again.

If the failure occurs the signal R/F goes to 1 (see note at fault A01=THP-HTS) and the display visualizes the presence of the failure all the time in which the MED is blocked.

### CAUSES OF THE FAILURE

- Input voltage to the MED less than 360 V
- Power relay upfront the MED broken
- Supply wires not connected or interrupted
- EMC/EMI filter broken
- MED internal failure

## **FAULT A18=ENC-KO: Digital speed sensor (ENCODER) failure or not connected**

The MED checks the presence of the digital speed sensor (ENCODER) for the corrected operation of the system. In the case that the signals coming from the speed sensor are wrong or absent, the MED marks the failure and interrupts its functionality.

Verify that the digital speed sensor (ENCODER) is correctly connected to the MED (see *"Simplified installation instructions for the drive MED-UP with encoder"* manual). The MED will not make any action if it will not have found signals suitable to its corrected operation.

If the failure occurs the signal R/F goes to 1 (see note at fault A01=THP-HTS) and the display visualizes the presence of the failure all the time in which the MED is blocked. The MED is restored automatically in order to resume the functionality of the system after 10 s except as described above.

### CAUSES OF THE FAILURE

- Digital speed sensor (ENCODER) not connected
- Digital speed sensor (ENCODER) out of order
- Digital speed sensor (ENCODER) interface out of order

## FAULT A22=OVC-MOT: Overcurrent

The MED has a current limiter that controls the current of the motor so that it remains under the maximum current allowed by the drive. If this does not happen, the MED marks the failure and interrupts its functionality.

Due to the dangerousness of the failure the protection stops the functionality of the MED after being sure for the existence of the failure. However the MED is restored automatically in order to resume the functionality of the system after 10 s except as described above.



WARNING: in case of the failure occurs again after the reset of it, switch off the MED and remove the cause of the problem before switching on the MED again.

If the failure occurs the signal R/F goes to 1 (see note at fault A01=THP-HTS) and the display visualizes the presence of the failure all the time in which the MED is blocked.

### CAUSES OF THE FAILURE

- Blocked motor, blocked pump, blocked valve, ...
- Motor supplied by two phases
- Motor in shortcircuit or with dispersion to ground
- Motor wire insulation not in good conditions
- IGBT module broken

## FAULT A90=TOUT DSP: DSP timeout

The functionality of the MED is governed by a microprocessor. If the operation of the microprocessor is interrupted or it is not performed in the corrected way, the MED goes in protection. In this case the only way to reset the system is to switch off and then to switch on again the MED.



WARNING: Before switch on again the MED wait the complete switch off of it indicated by the LEDs over the display.



WARNING: If at switch on the same modality of failure occurs, replace the MED.

## **FAULT A91=COM-KO: Communication problems while DSP and display are communicating**

The MED is provided with a display equipped with an internal microcontroller that communicates in real time with the microprocessor that supervises the operation of the inverter. When communication between the two devices presents problems, MED goes into protection and the only way that you have to reset the system is to switch off and then to switch on again the MED.



WARNING: Before switch on again the MED wait the complete switch off of it indicated by the LEDs over the display.



WARNING: If at switch on the same modality of failure occurs, replace the MED.

## **FAULT A92=COM TOUT: Timeout while DSP and display are communicating**

The MED is provided with a display equipped with an internal microcontroller that communicates in real time with the microprocessor that supervises the operation of the inverter. When the above microprocessor doesn't communicate with the microcontroller of the display, MED goes into protection and the only way that you have to reset the system is to switch off and then to switch on again the MED.



WARNING: Before switch on again the MED wait the complete switch off of it indicated by the LEDs over the display.



WARNING: If at switch on the same modality of failure occurs, replace the MED.

## 400 Fault history

From this menu you can query the MED to know the sequence of all faults that have occurred since its installation. The menu is read-only and the system is capable of storing a succession of at most 99 events. It is not possible to reset the data.

To see the list of alarms, shown in coded form (see table on page 22), select the parameter and press the SET key; then scroll through the list of events by pressing the UP or DOWN keys.



CAUTION: Parameter 400 set to “NO ALARM” means that there has been no failure. Press the MENU button to quit.



CAUTION: The faults stored in the alarm history are presented from most recent to oldest. This means that the most recent alarm is located in the position 01 of the fault history.



CAUTION: If during operation of the MED may occur more than 99 alarms, in the history there will be 99 most recent events only.



CAUTION: If the buzzer of the MED is enabled (parameter 04 = ON), a repeated series of five or more consecutive beeps indicate that:

- when you press UP key, you are already viewing the first event;
- when you press DOWN key, you are already viewing the last event.

## 5 Parameter reading

Through this menu you can query the MED for some of its functional parameters such as heat sink temperature, motor speed, power consumption from the mains, motor voltage, motor current, etc. The menu is reading only and it is not possible to reset the data.

Fig. 5.1 shows the structure of the menu.

When you are in this menu, press the SET button to go to the next screen, then use the UP or DOWN keys to display the desired parameter value. Press MENU to exit.



**CAUTION:** When you are in any parameter in this menu, the system doesn't return automatically to the main menu. Therefore, to exit this menu, you have to press the MENU key necessarily.



**CAUTION:** If the buzzer of the MED is enabled (parameter 04 = ON), a repeated series of five or more consecutive beeps indicate that:

- when you press UP key, you are already viewing the first menu or the first parameter of the menu;
- when you press DOWN key, you are already viewing the last menu or the last parameter of the menu.

Heatsink	50
Oil Temperat.	51
Motor speed	52
Input Power	53
Motor Volt.	54
Motor Current	55
Ext Commands	56
Nom. Speed UP	57
Nom. Speed DW	58
Antic. Index	59
Parameter	191
Parameter	192
Parameter	193
Parameter	194
Parameter	195
Parameter	196
Parameter	197
Parameter	198
Parameter	199
Parameter	200

Parameter	5
Reading	

Fig. 5.1

In the following table the meaning of every indicated data is reported.

#	Reading	Description
50	Heatsink	It indicates in real time the MED internal temperature
51	Oil Temperature <sup>(1)</sup>	It indicates in real time the oil temperature of the hydraulic power unit in which the motor is installed
52	Motor speed	It indicates in real time the motor speed
53	Input power	It indicates in real time the power from the mains
54	Motor voltage	It indicates in real time the motor voltage (RMS value)
55	Motor current	It indicates in real time the motor current (RMS value)
56	External commands <sup>(2)</sup>	It indicates the status of the following signals: ENABLE ( $\omega$ -rif/Enable) – Up – V – M. These signals are provided from the lift control panel to the terminal EXTERNAL REQUEST of the MED
57	Nominal speed UP <sup>(3)</sup>	It indicates the maximum speed in the previous upward race
58	Nominal speed DOWN	Reporting is not active. For future implementations
59	Anticavitation index	Reporting is not active. For future implementations
191	Parameter 191	Reserved
192	Parameter 192	Reporting is not active. For future implementations
193	Parameter 193	Reserved
194	Parameter 194	Reporting is not active. For future implementations
195	Parameter 195	Reporting is not active. For future implementations
196	Parameter 196	Reporting is not active. For future implementations
197	Parameter 197	Reporting is not active. For future implementations
198	Parameter 198	Reporting is not active. For future implementations
199	Parameter 199	Reporting is not active. For future implementations
200	Parameter 200	Reserved

<sup>(1)</sup>The indication of the oil temperature of the hydraulic power unit is carried out only if the motor is equipped with the sensor for the compensation of the pump leakage and this one is connected to the MED (see the manual “Simplified installation instructions for the drive MED-UP with encoder” – page 7/14).

<sup>(2)</sup>The presence of the corresponding signal (see the manual “Simplified installation instructions for the drive MED-UP with encoder” – page 7/14) is shown displaying between the < > characters:

- E for “ENABLE” signal;
- U for “Up” signal (upwards);
- V for “V” signal (fast);
- M for “M” signal (maintenance).

The absence of characters E, U, V, M between < > indicates therefore the absence of the corresponding signal.

<sup>(3)</sup>Does not give indications on the positioning and/or maintenance speed.



## 6 Fine adjustments

The menu enters in the set of the parameters for the advanced adjustments.



**WARNING:** Enter in this menu only if it is necessary, if you are very expert skilled and if you have the basics in the control of closed loop systems. In the event of difficulties please contact your dealer.



**CAUTION:** The modification of the parameters of this menu can affect the correct functionality of the elevator (high and dangerous vibrations). Modify the parameters only after having read the following instructions carefully.



**CAUTION:** Before modifying any parameter, annotate the previous parameters so that it can be returned to the previous values.

The menu is structured as in fig. 6.1. To modify the value of a parameter, select in the menu the parameter of interest and press the SET button to enter the edit mode: use the UP or DOWN button to set the parameter to the desired value. Confirm the value with the SET key and press MENU key to exit.



**CAUTION:** When you are in edit mode, the data of selected parameter is flashing. Press the SET button to confirm your selection or press the MENU key to exit.



**CAUTION:** If the buzzer of the MED is enabled (parameter 04 = ON), a repeated series of five or more consecutive beeps indicate that:

- when you press the UP or DOWN key in edit mode, you are setting a parameter beyond the range allowed;
- when you press UP key, you are already viewing the first menu or the first parameter of the menu;
- when you press DOWN key, you are already viewing the last menu or the last parameter of the menu.



**CAUTION:** To enable the proper functioning of the system, the value of each parameter may be automatically limited to a min or max value different from what has been shown in the following pages.

Looking at fig. 6.1 you can notice that:

- the parameters 60, 61, 62, 63 and 64 allow to tune the speed controller of the drive;
- if the sensor for dynamic compensation of the pump leakage is connected to the drive (see the manual *“Simplified installation instructions for the drive MED-UP with encoder”* – page 7/14), the parameters 150, 151, 152, 153 and 154 allow fine tuning of the dynamic compensation of the pump leakage, in order to maintain the upward speed of the car insensitive to variations in load and oil temperature of the hydraulic power unit. Normally it is not required any modification in comparison to their factory defaults. However if it was necessary to modify them for some reason, the procedure for their correct tuning is the following one:
  - set parameter 150 to the value of the ambient temperature (typically 25 °C);
  - set the parameter 151 to the value of the maximum temperature that can be presumed to reach the oil of the hydraulic power unit while the car is running with maximum load and number of travels per hour equal to those of project (generally this value is close to 60 °C);

- set the parameter 152 to the value of the maximum speed of the pump leakage (value generally close to 150-200 rpm for a new pump);
- tune the parameter 153 so that the car positioning speed with no load during upward travel remains the same with cold and hot oil. Generally the parameter does not require any settings other than the factory if parameter 32 (Motor Selection) – see page 18/49 of this manual has been set correctly;
- tune the parameter 154 so that the car positioning speed with full load during upward travel remains the same with cold and hot oil. Generally the parameter does not require any settings other than the factory if parameter 32 (Motor Selection) – see page 18/49 of this manual has been set correctly;



CAUTION: The settings of the parameters 150, 151, 152, 153 and 154 have no effect if the sensor for dynamic compensation of the pump leakage is not connected to the drive (see the manual “*Simplified installation instructions for the drive MED-UP with encoder*” – page 7/14).

- if the parameter 30 (Space Tune) is set to ON – see page 16/49 of this manual, the parameters 155 and 156 allow fine tuning of function for dynamic space recovery. Normally it is not required any modification in comparison to their factory defaults. However if it was necessary to modify them for some reason, the procedure for their correct tuning is the following one:
  - while the MED is recovering the saved positioning space, tune the parameter 155 so that in upward direction the car correctly stops on the floor and the approaching time to the floor has the desired duration;
  - tune the parameter 156 only if in upward direction the car tends to stop over the floor while the MED is recovering the saved positioning space and only if the change of the parameter 155 had no effect.



CAUTION: The settings of the parameters 155 and 156 have no effect if the parameter 30 (Space Tune) is not set to ON – see page 16/49 of this manual.



CAUTION: It is possible that the change of a single parameter related to the same function (tuning of the speed controller, fine tuning of the dynamic compensation of the pump leakage and fine tuning of the function for dynamic space recovery) also requires the modification of other parameters relating to the same function. Please observe as specified in this manual for correct setting.

In the following each parameter is described for a correct tune of it.

Fine Adjustments	6	Motion Tune State	60	It allows to enable the editing of the speed controller parameters
		Motion Tune Gain1	61	It allows to tune the parameter <b>Guad1</b> of the speed controller
		Motion Tune Gain2	62	It allows to tune the parameter <b>Guad2</b> of the speed controller
		Motion Tune Pole1	63	It allows to tune the parameter <b>Pole1</b> of the speed controller
		Motion Tune Pole2	64	It allows to tune the parameter <b>Pole2</b> of the speed controller
		Parameter	150	Minimum oil temperature (dynamic compensation of the pump leakage)
		Parameter	151	Maximum oil temperature (dynamic compensation of the pump leakage)
		Parameter	152	Maximum speed of the pump leakage (dynamic compensation of the pump leakage)
		Parameter	153	Minimum pressure to activate dynamic compensation of the pump leakage
		Parameter	154	Maximum pressure to activate dynamic compensation of the pump leakage
		Parameter	155	Compensation of the pump leakage in upwards (space tune)
		Parameter	156	Correction factor for space tune (upwards)
		Parameter	157	Function not allowed. It is used for other versions of MED
		Parameter	158	Function not allowed. It is used for other versions of MED
		Parameters	159÷161	Functions not allowed. They are used for other versions of MED
		Parameters	162÷180	Reserved

Fig. 6.1

## 60 Control tune

The menu enters in the set of the parameters for tuning of the speed controller of the drive. The menu structure is shown in fig. 60.1.

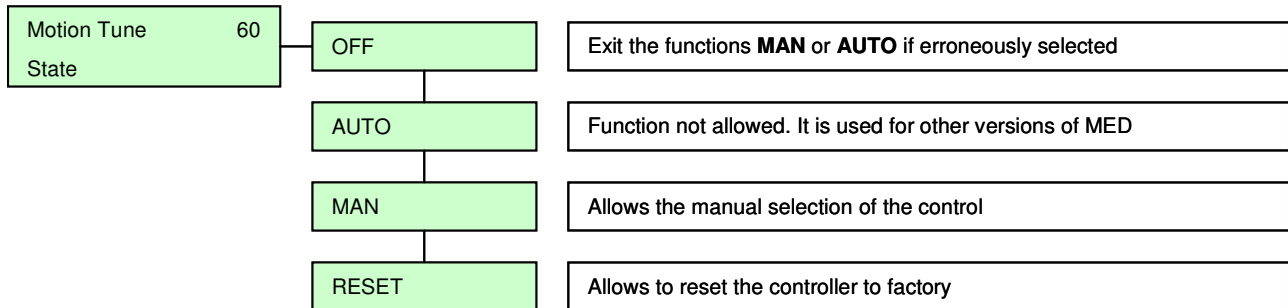

Fig. 60.1



WARNING: Normally it is not required to change any control parameter.



WARNING: The modification of the parameters of this menu can affect the correct functionality of the elevator (high and dangerous vibrations). Modify the parameters only after having read the following instructions carefully.

As shown in fig. 60.1, the menu has four states. Each state must be confirmed pressing the SET key. The function of each state is described in the following.

<b>OFF</b>	Exit the functions <b>MAN</b> or <b>AUTO</b> if erroneously selected
<b>AUTO</b>	Function not allowed. It is used for other versions of MED
<b>MAN</b>	Allows the manual selection of the control (see the description of the parameters 61, 62, 63 and 64 in the following pages)
<b>RESET</b>	Allows to reset the controller to factory

## 61 Control tune: GAIN1

This parameter is used to change the gain of the speed controller of the drive.

The possible values are reported in fig. 61.1. The nominal value, indicated with  $G_0$ , is 3.

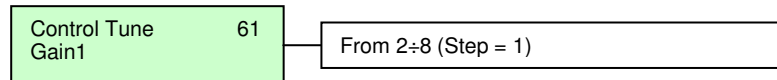

Fig. 61.1

The value of the gain of the speed controller can be changed manually accordingly to the following table which also shows the significance:

<i>Possible tuning value referred to the nominal one</i>							
	-3	-2	-1	0	+1	+2	+3
Gain	$8 G_0$	$4 G_0$	$2 G_0$	$G_0$	$\frac{1}{2} G_0$	$\frac{1}{4} G_0$	$\frac{1}{8} G_0$

where the value  $G_0$  is the default value mentioned above.



CAUTION: The value of this parameter may be automatically limited to a min or max value different from what has been shown in fig. 61.1.



CAUTION: This parameter has effect only if parameter 60 is set to **MAN**.



WARNING: Incorrect setting of this parameter can result in high and dangerous vibration in the system.

## 62 Control tune: GAIN2

Function not allowed. It is used for other versions of MED.

## 63 Control tune: POLE1

This parameter is used to change the pole of the speed controller of the drive.

The possible values are reported in fig. 63.1. The nominal value, indicated with  $H_0$ , is 3.

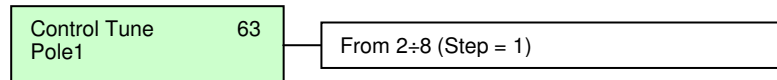

Fig. 63.1

The value of the pole of the speed controller can be changed manually accordingly to the following table which also shows the significance:

<i>Possible tuning value referred to the nominal one</i>							
	-3	-2	-1	0	+1	+2	+3
Pole	$8 H_0$	$4 H_0$	$2 H_0$	$H_0$	$\frac{1}{2} H_0$	$\frac{1}{4} H_0$	$\frac{1}{8} H_0$

where the value  $H_0$  is the default value mentioned above.



CAUTION: The value of this parameter may be automatically limited to a min or max value different from what has been shown in fig. 63.1.



CAUTION: This parameter has effect only if parameter 60 is set to **MAN**.



WARNING: Incorrect setting of this parameter can result in high and dangerous vibration in the system.

## 64 Control tune: POLE2

Function not allowed. It is used for other versions of MED.

## Parameter 150

If the sensor for dynamic compensation of the pump leakage is connected to the drive (see the manual “Simplified installation instructions for the drive MED-UP with encoder” – page 7/14), the parameter allows to change the minimum oil temperature of the hydraulic power unit which activates the dynamic compensation of the pump leakage; this allows to maintain the upward speed of the car insensitive to variations in load and oil temperature of the hydraulic power unit.

The possible values are reported in fig. 150.1. Increasing with UP the value the temperature is increased, while with DOWN the temperature is reduced. The nominal value is 25 (equal to 25 °C).

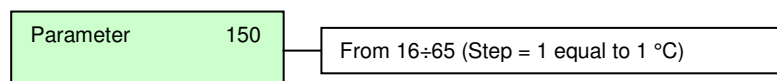

Fig. 150.1

When the car is not running for a long time, if the oil temperature of the hydraulic power unit is higher than 25 °C, increase with UP the value of the parameter; when the car is not running for a long time, if the oil temperature of the hydraulic power unit is lower than 25 °C, decrease with DOWN the value of the parameter.



CAUTION: The settings of this parameter have effect only if the sensor for dynamic compensation of the pump leakage is connected to the drive.



CAUTION: The goodness of the dynamic compensation of the pump leakage, which allows to maintain the upward speed of the system insensitive to variations in load and oil temperature of the hydraulic power unit, also depends on the setting of the parameters 151, 152, 153 and 154.

## Parameter 151

If the sensor for dynamic compensation of the pump leakage is connected to the drive (see the manual *"Simplified installation instructions for the drive MED-UP with encoder"* – page 7/14), the parameter allows to change the maximum temperature that the oil of the hydraulic power unit can reach while the car is running in its hardest conditions; this allows to maintain the upward speed of the car insensitive to variations in load and oil temperature of the hydraulic power unit.

The possible values are reported in fig. 151.1. Increasing with UP the value the temperature is increased, while with DOWN the temperature is reduced. The nominal value is 60 (equal to 60 °C).

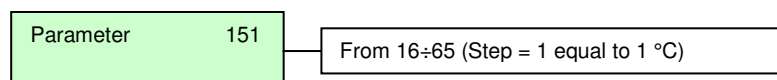

Fig. 151.1

While the car is running with maximum load and number of travels per hour equal to those of project, if the oil temperature of the hydraulic power unit is higher than 60 °C, increase with UP the value of the parameter; while the car is running with maximum load and number of travels per hour equal to those of project, if the oil temperature of the hydraulic power unit is lower than 60 °C, decrease with DOWN the value of the parameter.



CAUTION: The settings of this parameter have effect only if the sensor for dynamic compensation of the pump leakage is connected to the drive.



CAUTION: The goodness of the dynamic compensation of the pump leakage, which allows to maintain the upward speed of the system insensitive to variations in load and oil temperature of the hydraulic power unit, also depends on the setting of the parameters 150, 152, 153 and 154.



## Parameter 152

If the sensor for dynamic compensation of the pump leakage is connected to the drive (see the manual *"Simplified installation instructions for the drive MED-UP with encoder"* – page 7/14), the parameter allows to change the maximum speed of the pump leakage; this allows to maintain the upward speed of the car insensitive to variations in load and oil temperature of the hydraulic power unit.

The possible values are reported in fig. 152.1. Increasing with UP the value the speed of the pump leakage is increased, while with DOWN the speed of the pump leakage is reduced. The nominal value is 44.

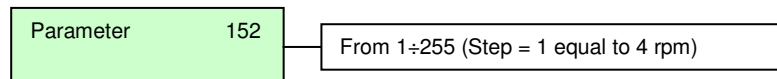

Fig. 152.1

If the maximum speed of the pump leakage is higher than 180 rpm, increase with UP the value of the parameter; if the maximum speed of the pump leakage is lower than 180 rpm, decrease with DOWN the value of the parameter. For information about the pump leakage, please refer directly to its manufacturer.



CAUTION: The settings of this parameter have effect only if the sensor for dynamic compensation of the pump leakage is connected to the drive.



CAUTION: The goodness of the dynamic compensation of the pump leakage, which allows to maintain the upward speed of the system insensitive to variations in load and oil temperature of the hydraulic power unit, also depends on the setting of the parameters 150, 151, 153 and 154.



CAUTION: Due to the wearing of the system parts, this parameter can require a successive tuning during the time.

## Parameter 153

If the sensor for dynamic compensation of the pump leakage is connected to the drive (see the manual “Simplified installation instructions for the drive MED-UP with encoder” – page 7/14), the parameter allows to change the minimum pressure of the hydraulic power unit which activates the dynamic compensation of the pump leakage; this allows to maintain the upward speed of the car insensitive to variations in load and oil temperature of the hydraulic power unit.

The possible values are reported in fig. 153.1. Increasing with UP the value the pressure is increased, while with DOWN the pressure is reduced. The nominal value depends on the characteristics (power and frequency) of the motor and is indicated in the tables below.

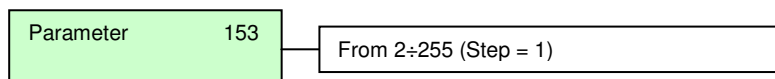

Fig. 153.1

<b>50 Hz motor</b>	
<i>Power [kW]</i>	<i>Value</i>
4,4	27
6	38
7,7	48
9,5	61
11	70
12	72
13	77
14,7	84
16	91
18,4	52
20	56
22,1	61
24	68
29	82
33	94
40	111
47	111

<b>60 Hz motor</b>	
<i>Power [kW]</i>	<i>Value</i>
4,4	33
6	42
7,5	50
9,5	63
11	73
12	76
13	84
15	97
18,5	61
22,1	69
24	76
29	95

<b>50 Hz motor - HE</b>	
<i>Power [kW]</i>	<i>Value</i>
1,1	6
1,5	8
2,2	12
3	16
4	20
5,5	27
7,5	37
9,2	47
11	56

If the car positioning speed with no load during upward travel, while the oil is hot, is higher than the car positioning speed with no load during upward travel, while the oil is cold, increase with UP the value of the parameter; if the car positioning speed with no load during upward travel, while the oil is hot, is lower than the car positioning speed with no load during upward travel, while the oil is cold, decrease with DOWN the value of the parameter.



**CAUTION:** The settings of this parameter have effect only if the sensor for dynamic compensation of the pump leakage is connected to the drive.



WARNING: If necessary, modify the setting of this parameter **only after correctly setting the parameter 32 (Motor selection)** – see page 18/49 of this manual. The setting of parameter 32 after changing the parameter 153 sets this one to the nominal value.



CAUTION: The goodness of the dynamic compensation of the pump leakage, which allows to maintain the upward speed of the system insensitive to variations in load and oil temperature of the hydraulic power unit, also depends on the setting of the parameters 150, 151, 152 and 154.

## Parameter 154

If the sensor for dynamic compensation of the pump leakage is connected to the drive (see the manual “Simplified installation instructions for the drive MED-UP with encoder” – page 7/14), the parameter allows to change the maximum pressure that the system can reach while the car is running in its hardest conditions; this allows to maintain the upward speed of the car insensitive to variations in load and oil temperature of the hydraulic power unit.

The possible values are reported in fig. 154.1. Increasing with UP the value the pressure is increased, while with DOWN the pressure is reduced. The nominal value depends on the characteristics (power and frequency) of the motor and is indicated in the tables below.

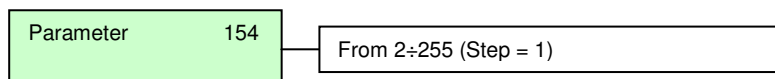

Fig. 154.1

<b>50 Hz motor</b>	
<i>Power [kW]</i>	<i>Value</i>
4,4	40
6	57
7,7	72
9,5	92
11	105
12	109
13	116
14,7	126
16	137
18.4	78
20	84
22,1	92
24	102
29	124
33	141
40	167
47	167

<b>60 Hz motor</b>	
<i>Power [kW]</i>	<i>Value</i>
4,4	50
6	63
7,5	76
9,5	95
11	110
12	115
13	126
15	145
18,5	92
22,1	104
24	114
29	143

<b>50 Hz motor - HE</b>	
<i>Power [kW]</i>	<i>Value</i>
1,1	9
1,5	12
2,2	18
3	25
4	31
5,5	41
7,5	56
9,2	71
11	84

If the car positioning speed with full load during upward travel, while the oil is hot, is higher than the car positioning speed with full load during upward travel, while the oil is cold, increase with UP the value of the parameter; if the car positioning speed with full load during upward travel, while the oil is hot, is lower than the car positioning speed with full load during upward travel, while the oil is cold, decrease with DOWN the value of the parameter.



**CAUTION:** The settings of this parameter have effect only if the sensor for dynamic compensation of the pump leakage is connected to the drive.



WARNING: If necessary, modify the setting of this parameter **only after correctly setting the parameter 32 (Motor selection)** – see page 18/49 of this manual. The setting of parameter 32 after changing the parameter 154 sets this one to the nominal value.



CAUTION: The goodness of the dynamic compensation of the pump leakage, which allows to maintain the upward speed of the system insensitive to variations in load and oil temperature of the hydraulic power unit, also depends on the setting of the parameters 150, 151, 152 and 153.

## Parameter 155

If the function of dynamic space recovery was activated (parameter 30 (Space Tune) = ON) and the drive is already recovering the saved positioning space – see page 16/49 of this manual, the parameter 155 allows to tune finely the pump leakage in upward direction; this allows to further improve the approaching time to the floor and find the correct stopping point of the car at the end of the deceleration, so as to minimize the usual long positioning times.

The possible values are reported in fig. 155.1. Increasing with UP the value the speed of the pump leakage is increased, while with DOWN the speed of the pump leakage is reduced. The nominal value is 45.

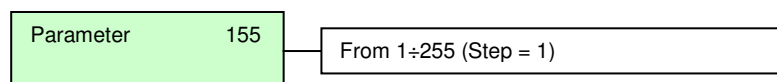

Fig. 155.1

If the approaching time to the floor in upward direction is too long, increase with UP the value of the parameter; if the approaching time to the floor in upward direction is too short and the cabin tends to stop over the floor, decrease with DOWN the value of the parameter.



**CAUTION:** The settings of this parameter have effect only if the parameter 30 (Space Tune) was set to ON and the MED was already recovering the saved positioning space.



**WARNING:** Reset the parameter to the nominal value, if you need to move upward deceleration magnets and / or upward floor magnets. Reset also the parameter to the nominal value if you need to disable and re-enable the function of dynamic space recovery.

## Parameter 156

This parameter has to be changed before activating the function of dynamic space recovery (parameter 30 (Space Tune) = ON) – see page 16/49 of this manual and enables to reduce the measured space between deceleration magnet and floor magnets while the MED is acquiring this space; therefore this parameter allows to modify the approaching time to the floor in upward direction, so as to avoid that the car tends to stop over the floor when the drive will recover the saved positioning space.

The possible values are reported in fig. 156.1. Increasing with UP the value, the amount subtracted from the acquired space is increased, while with DOWN the amount subtracted from the acquired space is reduced. The nominal value is 25.

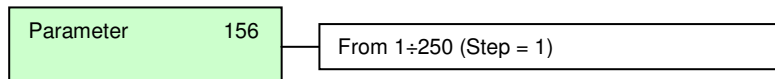

Fig. 156.1

While the MED is already recovering the saved positioning space, if the car tends to stop over the floor in upward direction, increase with UP the value of the parameter, reset and reactivate the function of dynamic space recovery for a new space reading (see page 16/49 of this manual); while the MED is already recovering the saved positioning space, if the approaching time to the floor in upward direction is too long, decrease with DOWN the value of the parameter, reset and reactivate the function of dynamic space recovery for a new space reading (see page 16/49 of this manual).



**WARNING:** Change this parameter before activating the function of dynamic space recovery.



**CAUTION:** The settings of this parameter have effect only when the MED is acquiring the space between deceleration magnet and floor magnets in upward direction. The parameter change when the MED is already recovering the saved positioning space has no effect.



**WARNING:** Reset the parameter to the nominal value, if you need to move upward deceleration magnets and / or upward floor magnets. Reset also the parameter to the nominal value if for reasons other than those listed above you need to disable and re-enable the function of dynamic space recovery.

## **Parameter 157**

Function not allowed. It is used for other versions of MED.

## **Parameter 158**

Function not allowed. It is used for other versions of MED.

## **Parameters from 159 to 161**

Functions not allowed. They are used for other versions of MED.

## **Parameters from 162 to 180**

Reserved. **DO NOT USE.**